

DVR User Manual

For H.264 4/8/16-channel digital video recorder
All rights reserved

CAUTION

- Please read this user manual carefully to ensure that you can use the device correctly and safely
- We do not warrant all the content is correct. The contents of this manual are subject to change without notice
- This device should be operated only from the type of power source indicated on the marking label. The voltage of the power must be verified before using. If not in use for a long time, pull out the plug from the socket
- Do not install this device near any heat sources such as radiators, heat registers, stoves or other device that produce heat
- Do not install this device near water. Clean only with a dry cloth
- Do not block any ventilation openings. And ensure well ventilation around the machine
- Do not power off the DVR at normal recording condition! The correct operation to shut off DVR is to stop recording firstly, and then select “shut-down” button at the right of the menu bar to exit, and finally to cut off the power.
- This machine is indoor using equipment. Do not expose the machine in rain or moist environment. In case any solid or liquid get into the machine’s case, please cut off the power supply immediately, and ask for qualified technicians to check the machine before restart
- Refer all servicing to qualified service personnel. No any parts repaired by yourself without technical aid or approval.
- This manual is suitable for 4/8/16-channel digital video recorders. All examples and pictures used in the manual are from 16-channel DVR.

Table of Contents

1	Introduction	7
	1.1 DVR Introduction.....	7
	1.2 Main Features	7
2	Hardware Installation	10
	2.1 Install Hard Drive &DVD Writer	10
	2.1.1 Install Hard Drive	10
	2.1.2 Install DVD Writer	11
	2.2 Front Panel Descriptions.....	11
	2.3 Rear Panel Instructions.....	13
	2.3.1 Rear Panel Interface	13
	2.4 Remote Controller.....	17
	2.5 Control with Mouse	19
	2.5.1 Connect Mouse.....	19
	2.5.2 Use Mouse.....	20
3	Basic Function Instruction	21
	3.1 Power On/Off	21
	3.1.1 Power on.....	21
	3.1.2 Power off.....	22
	3.2 Login	22
	3.3 Live preview	23
	3.3.1 Live playback	24
4	Main menu setup guide.....	25

Digital Video Recorder User Manual

4.1 Basic configuration	27
4.1.1 System	27
4.1.2 Time & date	28
4.1.3 DST	29
4.2 Live configuration	30
4.2.1 Live	31
4.2.2 Main monitor	32
4.2.3 SPOT	33
4.2.4 Mask	34
4.3 Record configuration	36
4.3.1 Enable	36
4.3.2 Record stream	37
4.3.3 Time	39
4.3.4 Stamp	40
4.3.5 Recycle record	41
4.4 Schedule configuration	41
4.4.1 Schedule	41
4.4.2 Motion	43
4.4.3 Sensor	44
4.5 Alarm configuration	44
4.5.1 Sensor	44
4.5.2 Motion	48
4.5.3 Video loss	50
4.5.4 Other alarm	51
4.5.5 Alarm out	53

Digital Video Recorder User Manual

4.6	Network configuration	54
4.6.1	Network.....	54
4.6.2	Sub stream	55
4.6.3	Email	57
4.6.4	Other settings.....	58
4.7	User management configuration	61
4.8	P.T.Z configuration.....	63
4.9	Advanced	68
4.9.1	Reset	69
4.9.2	Import/Export	69
5	Record search & playback and backup.....	70
5.1	Time search	70
5.2	Event search	71
5.3	File manager	72
5.4	Backup	73
6	Manage DVR.....	75
6.1	Check system information.....	75
6.1.1	System information	75
6.1.2	Event information	76
6.1.3	Log information	76
6.1.4	Network information	77
6.1.5	Online information	78
6.1.6	Manual alarm	79
6.1.7	Disk manager.....	79
6.1.8	Upgrade	80

Digital Video Recorder User Manual

	6.1.9 Logoff	80
7	Remote Surveillance	81
	7.1 Accessing DVR	81
	7.1.1 On LAN	81
	7.1.2 On WAN	83
	7.2 The remote live preview interface as below:	84
	7.3 Remote playback & backup	88
	7.3.1 Remote playback	88
	7.3.2 Remote backup	94
	7.4 Remote System configuration	95
	7.5 Remote Management	96
	Remote Information Search	96
8	Mobile Surveillance	97
	8.1 By Phones with Windows mobile	97
	8.2 By Phones with Symbian	100
	8.3 The operation method for iPhone mobile clients	103
	8.4 The installation & operation methods for Android mobile clients	109
	Appendix A FAQ	115
	Appendix B Calculate Recording Capacity	121
	Appendix C Compatible Devices	122
	Appendix D 4-CH DVR Specifications	123
	Appendix E 8-CH DVR Specifications	124
	Appendix F 16-CH DVR Specifications	125

1 Introduction

1.1 DVR Introduction

This model DVR (Digital Video Recorder) is designed specially for CCTV system. It adopts high performance video processing chips and embedded Linux system. Meanwhile, it utilizes many most advanced technologies, such as standard H.264 with low bit rate, Dual stream, SATA interface, VGA output mouse supported, IE browser supported with full remote control, mobile view(by phones), etc., which ensure its powerful functions and high stability. Due to these distinctive characteristics, it is widely used in banks, telecommunication, transportation, factories, warehouse, and irrigation and so on.

1.2 Main Features

COMPRESSION FORMAT

- Standard H.264 compression with low bit rate and better image quality

LIVE SURVEILLANCE

- Support HD VGA output
- Support channel security by hiding live display
- Display the local record state and basic information
- Support USB to make full control

RECORD MEDIA

- Support four SATA HDDs to record for a longer time without any limitation

BACKUP

- Support USB 2.0 devices to backup

- Support built-in SATA DVD writer to backup
- Support saving recorded files with AVI standard format to a remote computer through internet

RECORD & PLAYBACK

- Record modes: Manual, Schedule, Motion detection and Sensor alarm recording
- Support recycle after HDD full
- Resolution, frame rate and picture quality are adjustable
- 128MB for every video file packaging
- 4 audio channels available
- Two record search mode: time search and event search
- Support 1/4 screen playback simultaneously
- Support deleting and locking the recorded files one by one
- Support remote playback in Network Client through LAN or internet

ALARM

- 1 or 4 channel alarm output and 4/8/16 channel alarm input available
- Support schedule for motion detection and sensor alarm
- Support pre-recording and post recording
- Support linked channels recording once motion or alarm triggered on certain channel
- Support linked PTZ preset , auto cruise and track of the corresponding channel

PTZ CONTROL

- Support various PTZ protocols
- Support 128 PTZ presets and 8 auto cruise tracks
- Support remote PTZ control through internet

SECURITY

- Customize user right: log search, system setup, two way audio, file management, disk management, remote login, live view, manual record, playback, PTZ control and remote live view
- Support 1 administrator and 15 users.
- Support event log recording and checking, events unlimited

NETWORK

- Support TCP/IP, DHCP, PPPoE, DDNS protocol
- Support IE browser to do remote view
- Support setup client connection amount
- Support dual stream. Network stream is adjustable independently to fit the network bandwidth and environment.
- Support picture snap and color adjustment in remote live
- Support remote time and event search, and channel playback with picture snap
- Support remote PTZ control with preset and auto cruise
- Support remote full menu setup, changing all the DVR parameters remotely
- Support mobile surveillance by smart phones , symbian, WinCE, Iphone or Gphone, 3G network available
- Support CMS to manage multi devices on internet

2 Hardware Installation

 **Notice:** Check the unit and the accessories after getting the DVR.

Please disconnect the power before being connected to other devices. Don't hot plug in/out

2.1 Install Hard Drive & DVD Writer

2.1.1 Install Hard Drive

 **Notice:** 1. this series support four SATA hard drives or support three SATA hard drives plus one DVD writer. Please use the hard drive the manufacturers recommend specially for security and safe field.

2. Please calculate HDD capacity according to the recording setting. Please refer to “Appendix B Calculate Recording Capacity”.

Step1: Unscrew and Open the top cover

Step2: Connect the power and data cables. Place the HDD onto the bottom case as below.



Fig 2.1 Connect HDD

Step3: Screw the HDD

Note: For the convenience to install, please connect the power and data cables firstly, and then screw to fix.

2.1.2 Install DVD Writer

 **Notice:** 1. The writers must be the compatible devices we recommend. Please refer to “Appendix C Compatible Devices”

2. This device is only for backup

Step1: Unscrew and Open the top cover

Step2: Connect the power and data cables. Place the DVD writer onto the bottom case as below.

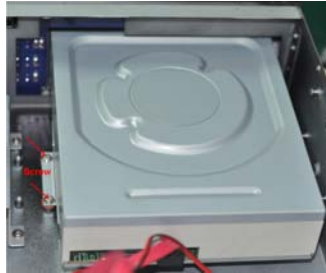





Fig 2.2 Connect the DVD Writer

Step3: Screw the DVD writer.

2.2 Front Panel Descriptions

- **Notice:** The front panel descriptions are only for reference; please make the object as the standard.

Digital Video Recorder User Manual

Item	Type	Name	Description
1	Work state indicator	Power	Power indicator, when connection , the light is blue
		HDD	When HDD is writing and reading , the light is blue
		Net	When access to network , the light is blue
		Backup	When backup files and data, the light is blue
		Play	When playing video, the light is blue
		REC	When recording, the light is blue
2	Compound button	AUDIO/+	1. Control voice 2. Increase the value in setup
		P.T.Z./-	1. Enter PTZ mode in live 2. Decrease the value in setup
		MENU	Enter menu in live
		INFO	Check recording data
		BACKUP	Enter backup mode in live
		SEARCH	Enter search mode
			Record manually
			Play/Pause
			Stop/Esc
			Fast forward
3	Digital button	1-9	Input number 1-9 or choose camera
		0/10+	Input number0, 10 and the above number together with other digital keys
4	Input button	Direction button	Change direction to select items
		Multi-screen	Change screen display mode like1/4/9/16 channel
		Enter button	Confirm selection
5	USB	USB port	To connect external USB devices like USB flash, USB HDD for backup or update firmware; or connect to USB mouse

2.3 Rear Panel Instructions

2.3.1 Rear Panel Interface

The rear Panel interface for 4-ch is shown as Fig 2.3:

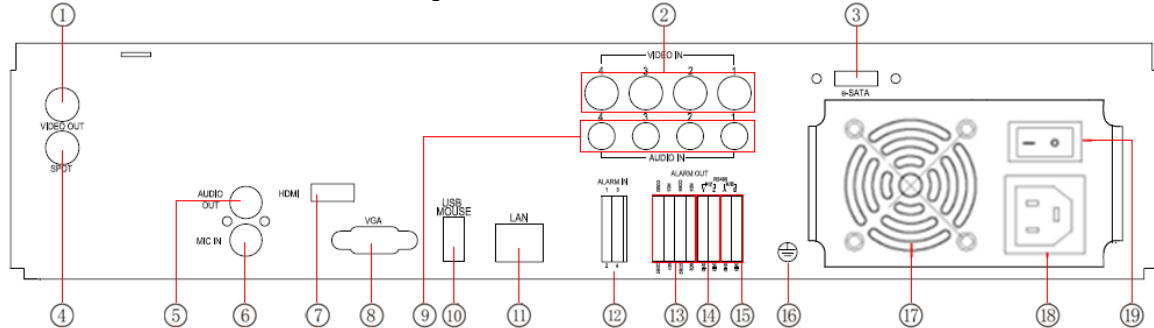

Fig 2.3 Rear Panel for 4-ch

Item	Name	Description
1	Video out	Connect to monitor
2	Video in	Video input channels from 1-4
3	E-SATA	Connect to HDD for backup (optional)
4	Spot out	Connect to monitor as an AUX output channel by channel. Only video display, no menu show
5	Audio out	Audio output, connect to the sound box
6	MIC IN	Talk
7	HDMI port	Connect to high-definition display device (optional)
8	VGA port	VGA output, connect to monitor
9	Audio in	4 CH Audio input

Digital Video Recorder User Manual

Item	Name	Description
10	USB port	To connect external USB devices like USB flash, USB HDD for backup or update firmware; or connect to USB mouse
11	LAN	Network port
12	ALARM IN	Connect to external sensor1-4
13	ALARM OUT	4ch relay output. Connect to external alarm.
14	P/Z	Connect to speed dome
15	K/B	Connect to keyboard
16	GND	Grounding
17	FAN	For cooling the device
18	POWER INPUT	AC 110V-220V
19	POWER SWITCH	Switch on/off

Tab 2.1 Definitions of Front Panel Buttons

The rear Panel interface for 8-ch is shown as Fig 2.4:

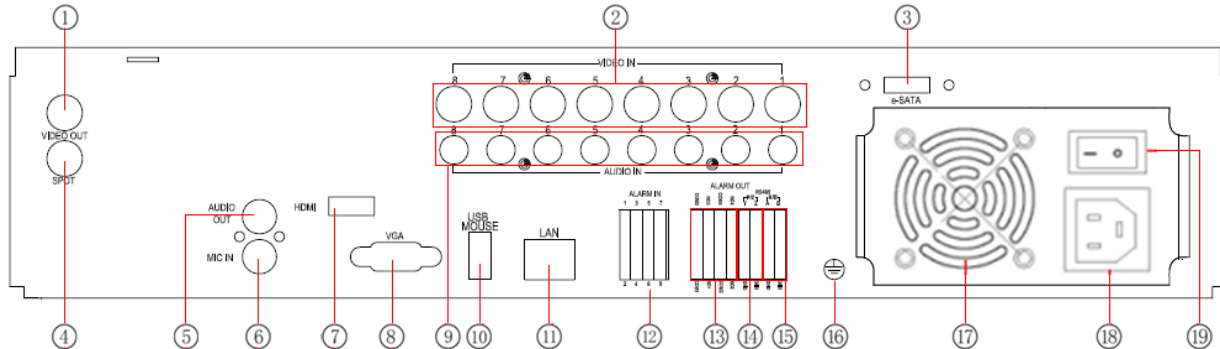

Fig 2.4 Rear Panel for 8-ch

Digital Video Recorder User Manual

Item	Name	Description
1	Video out	Connect to monitor
2	Video in	Video input channels from 1-8
3	E-SATA	Connect to HDD for backup (optional)
4	Spot out	Connect to monitor as an AUX output channel by channel. Only video display, no menu show
5	Audio out	Audio output, connect to the sound box
6	MIC IN	Talk
7	HDMI port	Connect to high-definition display device (optional)
8	VGA port	VGA output, connect to monitor
9	Audio in	8 CH Audio input
10	USB port	To connect external USB devices like USB flash, USB HDD for backup or update firmware; or connect to USB mouse
11	LAN	Network port
12	ALARM IN	Connect to external sensor1-8
13	ALARM OUT	4ch relay output. Connect to external alarm.
14	P/Z	Connect to speed dome
15	K/B	Connect to keyboard
16	GND	Grounding
17	FAN	For cooling the device
18	POWER INPUT	AC 110V-220V
19	POWER SWITCH	Switch on/off

Tab 2.2 Definitions of Front Panel Buttons

The rear Panel interface for 16-ch is shown as Fig 2.5:

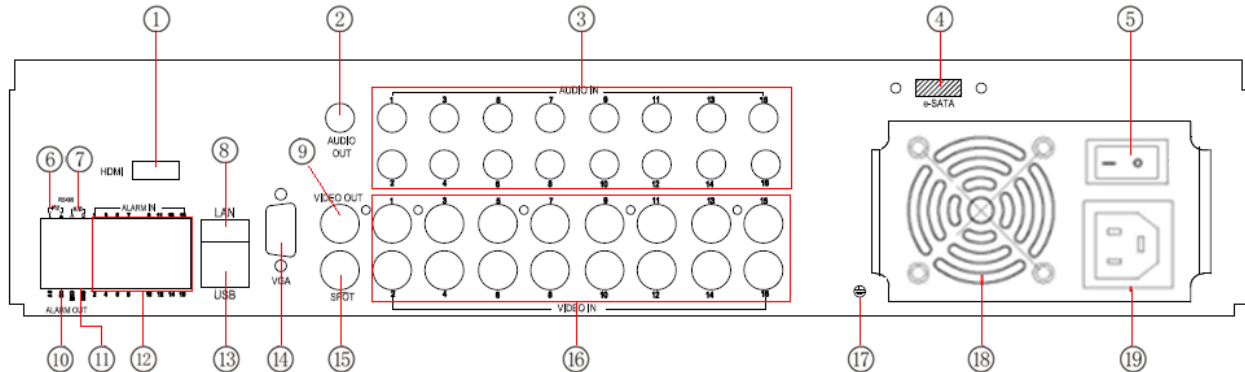

Fig 2.5 Rear Panel for 16-ch

Item	Name	Description
1	HDMI port	Connect to high-definition display device (optional)
2	Audio out	Audio output, connect to the sound box
3	Audio in	16 CH Audio input
4	E-SATA	Connect to HDD for backup (optional)
5	POWER SWITCH	Switch on/off
6	P/Z	Connect to speed dome
7	K/B	Connect to keyboard
8	LAN	Network port
9	Video out	Connect to monitor
10	ALARM OUT	1ch relay output. Connect to external alarm.
11	GND	Grounding
12	ALARM IN	Connect to external sensor1-16

Item	Name	Description
13	USB port	To connect external USB devices like USB flash, USB HDD for backup or update firmware; or connect to USB mouse
14	VGA port	VGA output, connect to monitor
15	Spot out	Connect to monitor as an AUX output channel by channel. Only video display, no menu show
16	Video in	Video input channels from 1-16
17	GND	Grounding
18	FAN	For cooling the device
19	POWER INPUT	AC 110V-220V

Tab 2.3 Definitions of Rear Panel Buttons

2.4 Remote Controller

It uses two AAA size batteries and works after loading batteries as following:

Step1: Open the battery cover of the Remote Controller

Step2: Place batteries. Please take care the poles (+ and -)

Step3: Replace the battery cover

 **Notice:** Frequently defect checking as following

1. Check batteries poles
2. Check the remaining charge in the batteries
3. Check IR controller sensor is mask

If it still doesn't work, Please change a new remote controller to try, or contact your dealers

The interface of remote controller is shown in Fig2.6 Remote Controller.

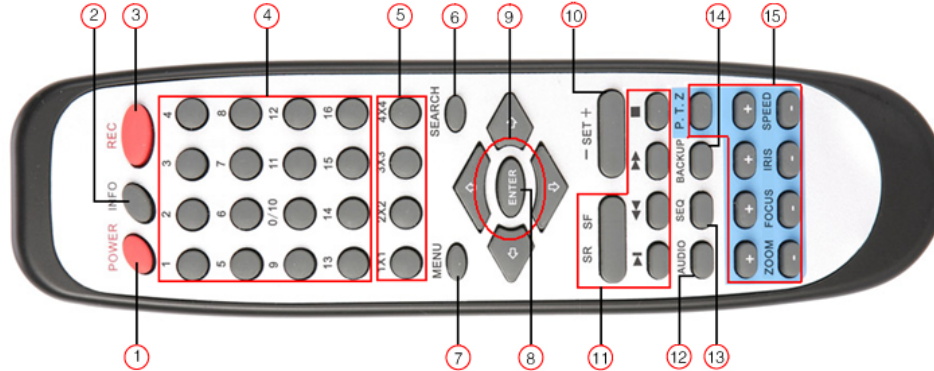

Fig 2.6 Remote Controller

Item	Name	Function
1	Power Button	Soft switch off to stop firmware running. Do it before power off.
2	INFOR Button	Get information about the DVR like firmware version, HDD information
3	REC Button	To record manually
4	Digital Button	Input digital or choose camera
5	Multi Screen Button	To choose multi screen display mode
6	SEARCH Button	To enter search mode
7	MENU Button	To enter menu
8	ENTER Button	To confirm the choice or setup
9	Direction Button	Move cursor in setup or pan/title PTZ
10	+/- Button	To increase or decrease the value in setup

Item	Name	Function
11	Playback Control Button	To control playback, Fast forward/rewind/stop/single frame play
12	AUDIO Button	To enable audio output in live mode
13	Auto Dwell Button	To enter auto dwell mode
14	BACKUP Button	To enter backup mode
15	PTZ Control Button	To control PTZ camera: Move camera/ZOOM/FOCUS/IRIS/SPEED control

Operation processes with remote controller to control multi-DVR

The device ID of the DVR is 0. When use of remote controller to control single DVR, it's not necessarily to reset the device ID, user can do operation directly; when control multiple DVR with remote controller, please refer to below steps:

Step1: Activate remote controller to control DVR: enable DVR: turn the IR sensor of the remote controller to the IR receiver that on the front panel, press the number key 8 twice, then input device ID (Range from: 0-65535; the default device ID is 0.) with other digital number: 0-9, after that, press ENTER button to confirm.

Step2: User can check the device ID by enter into System configuration→Basic configuration→device ID. User also can set other DVRs with the same device ID. For more convenient to operate, we don't recommend user to set the device ID too long.

Step3: Cancel controller to control DVR: turn the IR sensor of the remote controller to the IR receiver that on the front panel, press the number key 8 twice, then input the device ID that needs to be cancelled from controlling, press ENTER button to confirm. After that, the DVR will not be controlled by remote controller.

2.5 Control with Mouse

2.5.1 Connect Mouse

It supports USB mouse through the ports on the rear panel, please refer to Fig 2.6 Remote Controller.

 **Notice:** If mouse is not detected or doesn't work, check below steps:

1. Make sure the mouse plugs in the USB mouse port not the USB port

2. Change a mouse to try

2.5.2 Use Mouse

The structure of the main menu is shown in Fig 2.6 Remote Controller.

In live: Double-click left button on one camera to be full screen display. Double-click again to return to the previous screen display.

Click right button to show the control bar at the bottom of the screen as Fig 2.6 Remote Controller. Here are all control and setup. Click right mouse again to hide the control bar.

In setup: Click left button to enter. Click right button to cancel setup, or return to the previous.

If want to input the value, move cursor to the blank and click. An input window will appear as Fig2.7. It supports digitals, letters and symbols input.

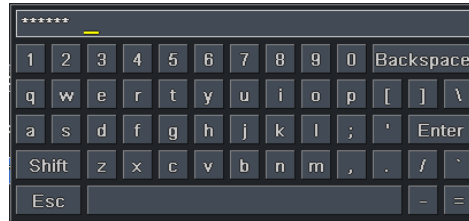

Fig 2.7 Digital Numbers and Letters Input Window

Users can change some value by the wheel, such as time. Move cursor onto the value, and roll the wheel when the value blinks.

It supports mouse drag. I.e. Set motion detection area: click customized, hold left button and drag to set motion detection area. Set schedule: hold left button and drag to set schedule time

In playback: Click left button to choose the options. Click right button to return to live mode.

In backup:

Click left button to choose the options. Click right button to return to previous picture.

In PTZ control: Click left button to choose the buttons to control the PTZ. Click right button to return to live.

- **Notice:** *Mouse is the default tool in all the operation below unless Exceptional indication.*

3 Basic Function Instruction

3.1 Power On/Off

Before you power on the unit, please make sure all the connection is good.

3.1.1 Power on

Step1: connect with the source power; switch on the power button near the power port on the rear panel

Step2: the device will be loaded, and the power indicator will display blue

Step3: before start, a WIZZARD dialogue box will be pop-up (refer to below picture) and show some information about time zone and time setup.

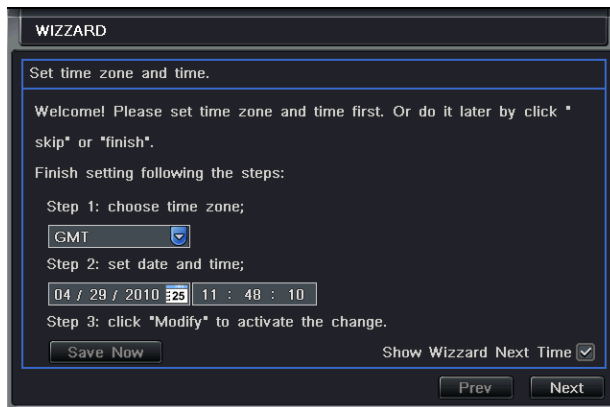

After the device power on, if there is no menu or only has live image display, user can long press ESC button to switch.

- **Notice:** this serial device can only display menu on VGA monitor or BNC monitor at one time, if there is live image display without menu display, please check up whether other device has menu display firstly, or long press ESC key to wait for login dialog box to appear. Long press ESC key can switch the output between BNC and VGA.

3.1.2 Power off

User can power off the device by using remote controller、 keyboard and mouse.

By remote controller:

Step1: press Power button, the Shut down window will appear, click OK, the unit will power off after a while.

Step2: disconnect the power

By keyboard and mouse:

Step1: enter into  Menu, then select "System Shut Down" icon, the Shut down window will appear

Step2: click OK, the unit will power off after a while.

Step3: disconnect the power

3.2 Login

User can login and logout the DVR system. User cannot do any other operations except changing the multi-screen display once logout.



Fig 3-1 Login

- *Notice: the default user name and password is "admin" and 123456 "*
- *The concrete operation steps for change password, add or delete user please refer to Fig 3.7 User management configuration for more details.*

3.3 Live preview



Fig 3-2 live preview interface

The explanation of symbol in the live preview interface:

Symbol	Meaning	Symbol	Meaning
Green	Manual record or time record	Red	Alarm record
Yellow	Motion detection record	Figure icon	Move event

3.3.1 Live playback

Click Play  button to playback the record. Refer to Figure3-3. User can do concrete operation by click the buttons on screen.

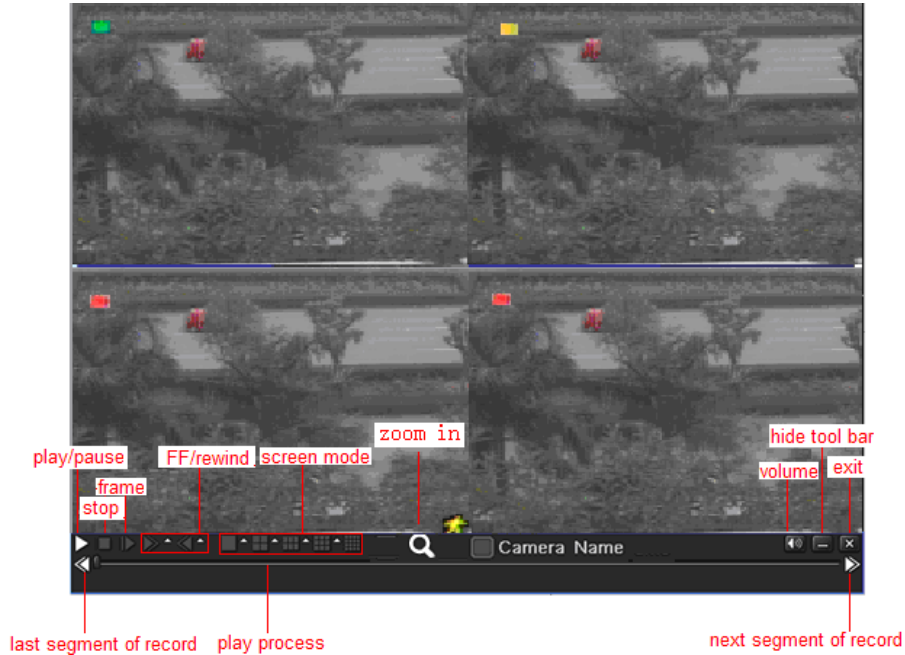

Fig 3-3 live playback

4 Main menu setup guide

Click right mouse or press ESC button on the front panel, the control bar will display on the bottom of the screen, refer to Fig 4-1:

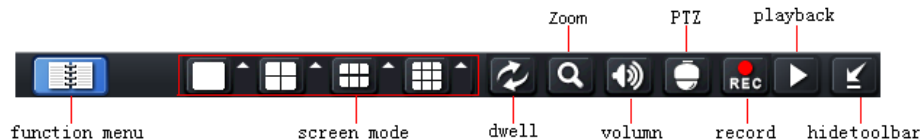
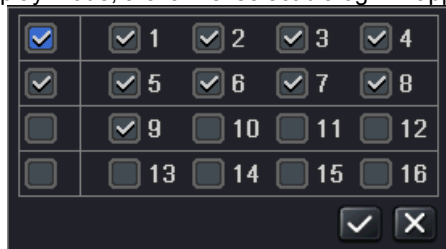



Fig 4-1 main menu toolbar

Click the  icon beside the screen display mode, a channel select dialog will appear as below:



Take 8-channel DVR for example: user can tick off 8 channels form 1-ch to 16-ch at random to display the live pictures. Then click  button to confirm the setting.

Click Menu  button, the interface will pop-up as Fig 4-2; press MENU button on the front panel or operate with remote controller also can display the main menu.



Fig 4-2 main menu

Click Setup icon will pop-up the configuration menu:



4.1 Basic configuration

Basic configuration includes three sub menus: system、date& time and DST.

4.1.1 System

Step1: enter into system configuration→basic configuration→system; refer to Fig 4-3:



Fig 4-3 basic configuration-basic

Step2: in this interface user can setup the device name, device ID, video format, max network users, VGA resolution and language. The definitions for every parameters display as below:

Device name: the name of the device. It may display on the client end or CMS that help user to recognize the device remotely.

Video format: two modes: PAL and NTSC. User can select the video format according to that of camera.

Password check: enable this option, user needs to input user name and password can do corresponding operations with the relevant right in system configuration.

Show time: display time in live.

Show wizard: tick off this item, there will display an opening wizard with time zone and time setup information

Max network uses: set the max user amount of network connection

VGA resolution: the resolution of live display interface, range from: VGA800*600、VGA1024*768、VGA1280*1024and CVBS

Note: When switch between VGA and CVBS will change the menu output mode, please connect to relevant monitor.

Language: setup the menu language.

Note: after changed the language and video output, the device needs to login again.

4.1.2 Time & date

Step1: enter into system configuration→basic configuration→time & date; refer to Fig 4-4:

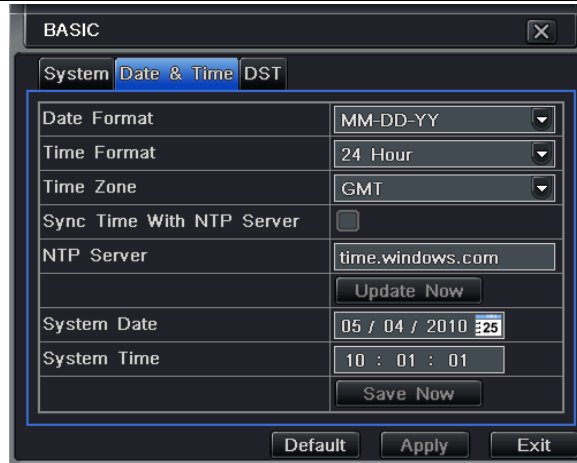

Fig 4-4 basic configuration-time & date

Step2: set the date format, time format, time zone in this interface; tick off “sync time with NTP server” to refresh NTP server date; user also can adjust system date manually

Step3: click “default” button to resort default setting; click “apply” button to save the setting; click “exit” button to exit current interface.

4.1.3 DST

Step1: enter into system configuration→basic configuration→DST; refer to Fig 4-5:

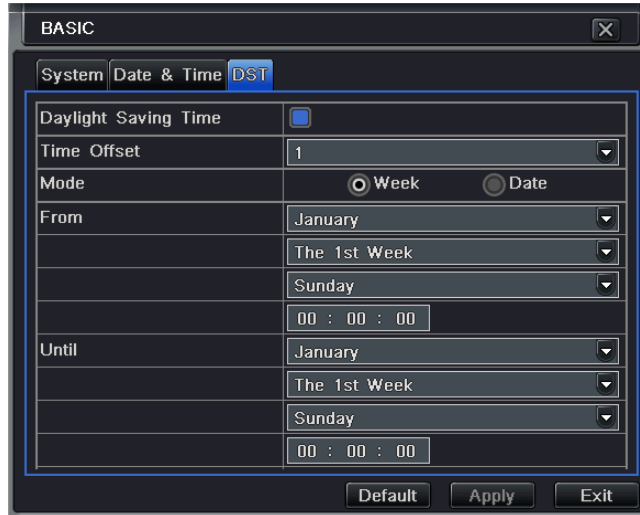

Fig 4-5 basic configuration-DST

Step2: in this interface, enable daylight saving time, time offset, mode, start & end month/week/date, etc.

Step3: click "default" button to resort default setting; click "apply" button to save the setting; click "exit" button to exit current interface.

4.2 Live configuration

Live configuration includes four submenus: live, main monitor, SPOT and mask.

4.2.1 Live

In this interface, user can setup camera name, adjust colors: brightness, hue, saturation and contrast.

Step1: enter into system configuration→live configuration→live; refer to Fig 4-6:

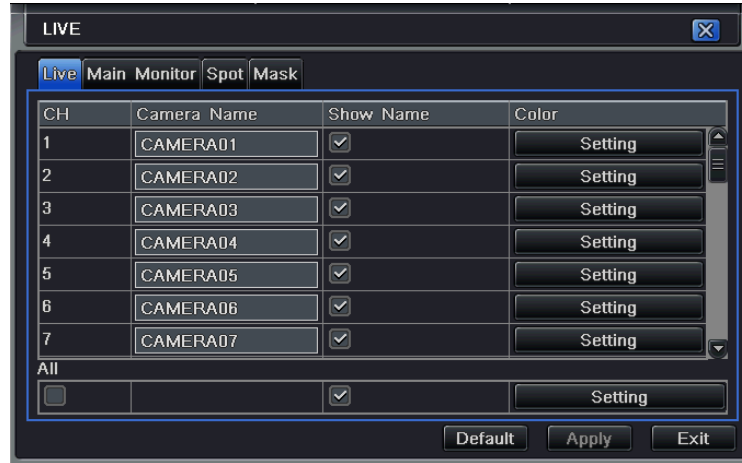

Fig 4-6 live configuration→live

Step2: tick off camera name; click “setting” button, a window will pop-up as Fig 4-7:

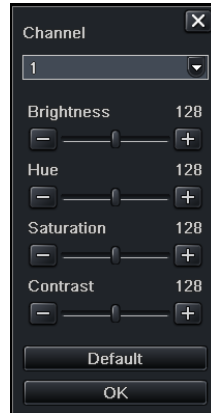

Fig 4-7 live-color adjustment

Step3: in this interface, user can adjust brightness, hue, saturation and contrast in live; click “default” button to resort default setting, click “OK” button to save the setting.

Step4: user can setup all channels with same parameters, tick off “all”, then do relevant setup.

Step5: click “default” button to resort default setting; click “apply” button to save the setting; click “exit” button to exit current interface.

4.2.2 Main monitor



Step1: enter into system configuration→live configuration→main monitor; refer to Fig 4-8:



Fig 4-8 live configuration-main monitor

Step2: select split mode: 1×1、2×2、2×3、3×3、4×4 and channel

Step3: dwell time: the time interval for a certain dwell picture display switching to next dwell picture display

Step4: selected the split mode, then setup current picture group. Click  button to setup the previous channel groups of dwell picture, click  button to set the latter channel groups of dwell picture.

Step5: click “default” button to resort default setting; click “apply” button to save the setting; click “exit” button to exit current interface.

4.2.3 SPOT

Step1: enter into system configuration→live configuration→SPOT; refer to Fig 4-9:

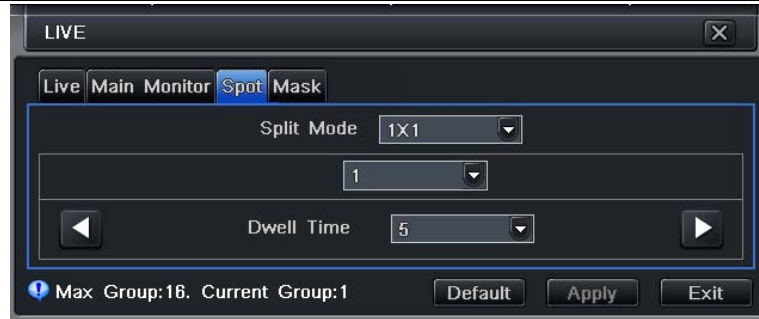



Fig 4-9 live configuration-SPOT

Step2: select split mode: 1×1and channel

Step3: dwell time: the time interval for a certain dwell picture display switching to next dwell picture display

Step4: selected the split mode, then setup current picture group. Click  button to setup the previous channel groups of dwell picture, click  button to set the latter channel groups of dwell picture.

Step5: click “default” button to resort default setting; click “apply” button to save the setting; click “exit” button to exit current interface

4.2.4 Mask

User can setup private mask area on the live image picture, max threes areas.



Fig 4-10 live configuration-mask

Setup mask area: click Setting button, enter into live image to press left mouse and drag mouse to set mask area, refer to below picture. Click Apply button to save the setting.

Delete mask area: select a certain mask area, click left mouse to delete that mask area, click Apply button to save the setting.



Setup mask area



Live image mask area

4.3 Record configuration

Record configuration includes five sub menus: enable, record bit rate, time, recycle record and stamp.

4.3.1 Enable

Step1: enter into system configuration→record configuration→enable; refer to Fig 4-11:



Fig 4-11 record configuration-enable

Step2: tick off record, audio and record time

Step3: user can setup all channels with same parameters, tick off “all”, then to do relevant setup.

Step4: click “default” button to resort default setting; click “apply” button to save the setting; click “exit” button to exit current interface.

Definitions and descriptions of Record:

Parameter	Meaning
Record	Record switch of every channels
Audio	Enable live record audio

4.3.2 Record stream

Step1: enter into system configuration→record configuration→record bit rate; refer to Fig 4-12:



Fig 4-12 record configuration-record bit rate

Step2: setup rate, resolution, quality, encode and max bit stream

Step3: user can setup all channels with same parameters, tick off “All”, then to do relevant setup.

Step4: click “default” button to resort default setting; click “apply” button to save the setting; click “exit” button to exit current interface.

Note: if the rate value set is over high the maximum resources of the device, the value will be adjusted automatically.

Definitions and descriptions of Record stream:

Parameter	Meaning
Rate	Range from: 1-30 (NTSC) 1-25(PAL)
Resolution	Support CIF and D1
Quality	The quality of recorded images. The higher the value is, the clearer the recorded

	image is. Six options: lowest, lower, low, medium, higher and highest.
Encode	VBR and CBR
Max bit stream	Range from: 64 Kbps、128 Kbps、256 Kbps、512 Kbps、768 Kbps、1Mbps、2 Mbps

4.3.3 Time

Step1: enter into system configuration→record configuration→ time; refer to Fig 4-13:

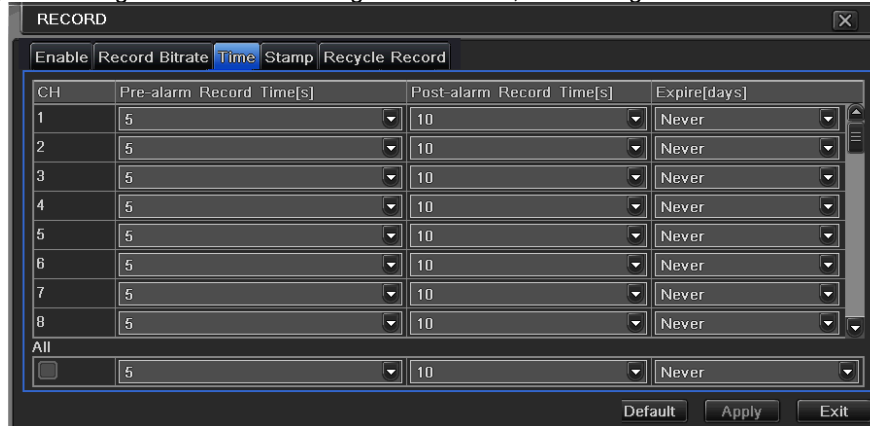

Fig 4-13 record configuration-time

Pre-alarm record time: the record time before event happen i.e. record time before motion detection or sensor alarm is triggered.

Post-alarm record: set the post recording time after the alarm is finished, five options: 10s、15s、20s、30s and 60s.

Expire time: the hold time of saved records. If the set date is overdue, the record files will be deleted automatically.

Step2: user can setup all channels with same parameters, tick off “all”, then to do relevant setup.

Step3: click “default” button to resort default setting; click “apply” button to save the setting; click “exit” button to exit current interface.

4.3.4 Stamp

Stamp: User can overlap the channel name and time stamp on video.

Step1: enter into system configuration→ record configuration→ stamp; refer to Fig 4-14:

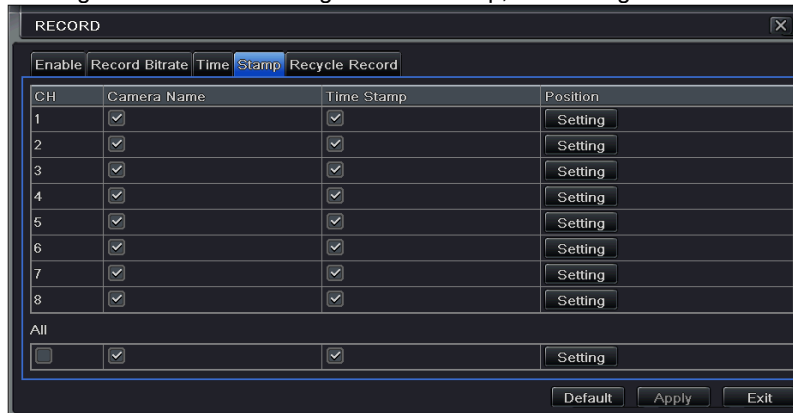

Fig 4-14 record configuration-stamp

Step2: tick off camera name, time stamp; click Set button, user can use cursor to drag the camera name and time stamp in random positions, refer to below Figures:



Before drag

after drag

Step3: user can setup all channels with same parameters, tick off “all”, then to do relevant setup.

Step4: click “default” button to resort default setting; click “apply” button to save the setting; click “exit” button to exit current interface.

4.3.5 Recycle record

Step1: enter into system configuration→record configuration→recycle record;

Step2: tick off recycle record, the recycle record function will enable, it will cover the earlier recorded files and keep recoding when HDD is full; if disenable this function, it will stop recording when HDD is full.

Step3: click “default” button to resort default setting; click “apply” button to save the setting; click “exit” button to exit current interface.

4.4 Schedule configuration

Schedule configuration includes three sub menus: schedule, motion and alarm.

4.4.1 Schedule

The volume means the seven days of a week from Monday to Sunday, the row means 24 hours of a day. Click the grid to do relevant setup. Blue means checked area, gray means unchecked area.

Step1: enter into system configuration→schedule configuration→schedule; refer to Fig 4-15:

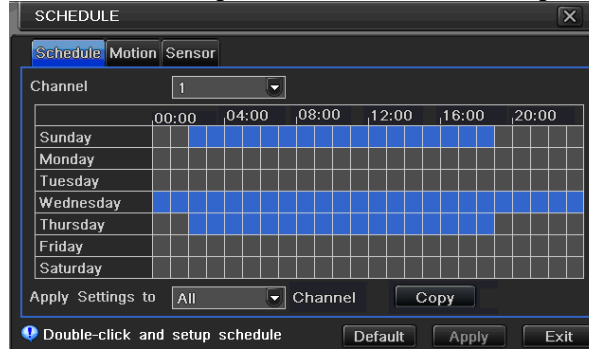

Fig 4-15 schedule configuration-schedule

Step2: select channel, double-click and a dialog box will pop-up as Fig 4-16, user can edit week schedule:

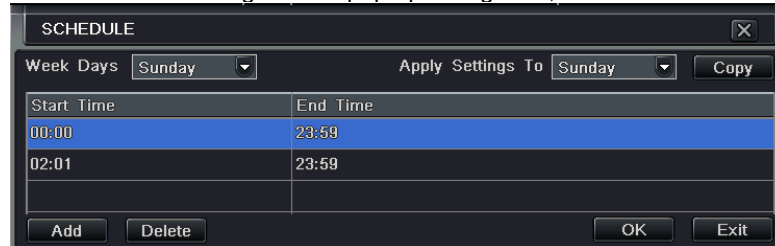

Fig 4-16 schedule-week schedule

① Click “add” button to add a certain day schedule; click “delete” button to delete the selected schedule; Copy: user can copy the specify schedule to other dates.

Click “OK” button to save the setting, click “Exit” button to exit current interface.

② User can apply the schedule setting of certain channel to other or all channels, just only select channel and click “Copy” button.

Step3: click “default” button to resort default setting; click “apply” button to save the setting; click “exit” button to exit current interface.

4.4.2 Motion

Step1: enter into system configuration→schedule configuration→motion; refer to Fig 4-17:

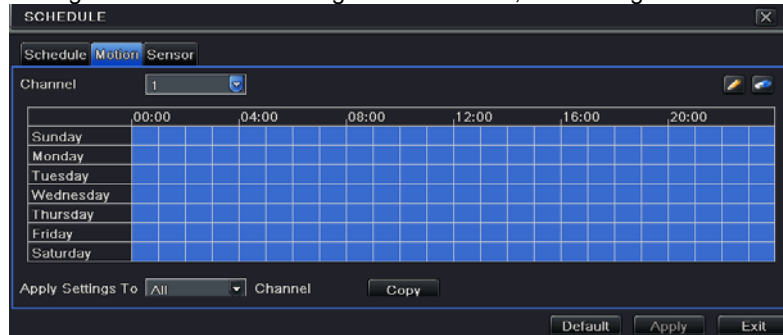

Fig 4-17 schedule configuration-motion

Step2: the setup steps of motion are familiar with schedule; user can refer to 4.4.1 Schedule for details.

Note: the default schedule of motion detection is full-selected, that is, the color of schedule setting interface is blue.

4.4.3 Sensor

Step1: enter into system configuration→schedule configuration→alarm; refer to Fig 4-18:

Step2: the setup steps of alarm are familiar with schedule; user can refer to 4.4.1 Schedule for details.

Note: the default schedule of sensor is full-selected, that is, the color of schedule setting interface is blue.

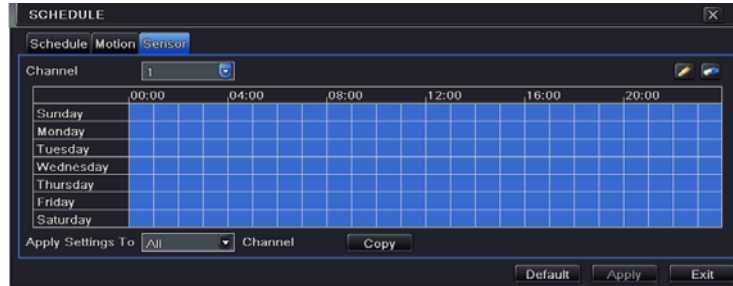

Fig 4-18 schedule configuration-sensor

4.5 Alarm configuration

Alarm configuration includes five sub menus: sensor, motion, video loss, other alarm and alarm out.

4.5.1 Sensor

Sensor includes three sub menus: basic, alarm handling and schedule.

① Basic

Step1: enter into system configuration→alarm configuration→sensor→basic; refer to Fig 4-19:



Fig 4-19 alarm configuration-sensor-basic

Step2: enable sensor alarm, set the alarm type according to triggered alarm type. Two option: NO and NC.

Step3: user can setup all channels with same parameters, tick off “all”, then to do relevant setup.

Step4: click “default” button to resort default setting; click “apply” button to save the setting; click “exit” button to exit current interface.

② Alarm handling

Step1: enter into system configuration→alarm configuration→sensor→alarm handling; refer to Fig 4-20:



Fig 4-20 alarm configuration-sensor-alarm handling

Step2: select hold time, click Trigger button, and a dialog box will pop-up as Fig 4-21:



Fig 4-21 alarm handling-trigger

Step3: tick off Buzzer, there will be triggered buzzer alarm out;

Full screen alarm: when triggered alarm, there will pop up full screen alarm;

Email: tick of this function, when an alarm triggered, a notification email will be sent to user's designed email box including trigger events, time, snap pictures, device name, ID camera name etc.

To alarm out: tick off the channel, there will be triggered alarm out in the designated channel. Click OK button to save the setting; click Exit button to exit the current interface.

To record: tick off recoding channels, it will record the camera when alarm triggered. Click OK button to save the setting; click Exit button to exit the current interface.

To P.T.Z: set linked preset and cruise for alarm. User can select any channel and multi channels as linked channels. Click OK button to save the setting; click Exit button to exit the current interface.

Step4: user can setup all channels with same parameters, tick off "all", then to do relevant setup.

Step5: click "default" button to resort default setting; click "apply" button to save the setting; click "exit" button to exit current interface.

③ Schedule

Step1: enter into system configuration→alarm configuration→sensor→schedule; refer to Fig 4-22:

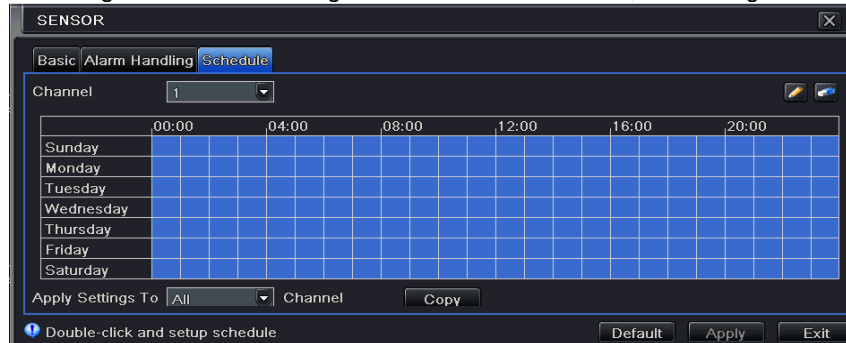

Fig 4-22 sensor-schedule

Step2: the setup steps of sensor schedule are familiar with schedule; user can refer to 4.4.1 Schedule for details.

Note: the default schedule of sensor is full-selected, that is, the color of schedule setting interface is blue.

4.5.2 Motion

Motion includes two sub menus: motion and schedule.

① Motion

Step1: enter into system configuration→alarm configuration→motion; refer to Fig 4-23:

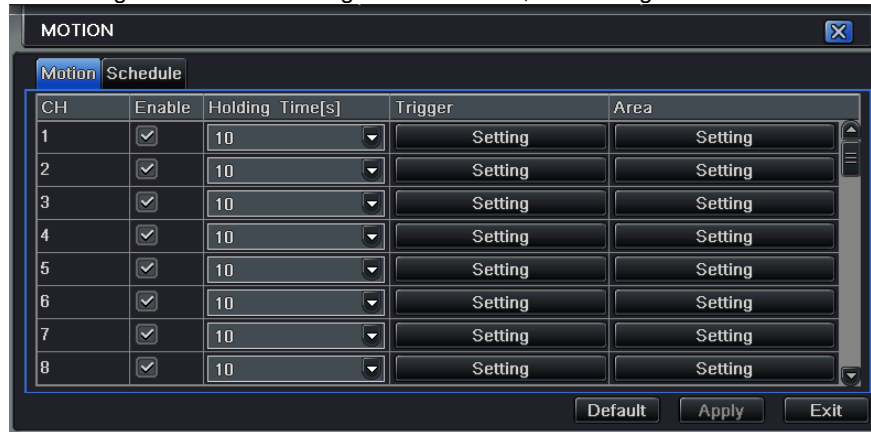

Fig 4-23 alarm configuration-motion





Step2: enable motion alarm, set alarm hold time which means time interval between two adjacent detective motions. If there is other motion detected during the interval period which is considered continuous movement; otherwise, it will be considered that those two adjacent detective motions are two different motion events. Click Trigger button, a dialog box will pop-up:

Step3: the setup steps of motion trigger are familiar with alarm handling; user can refer to Chapter 4.5.1 Sensor →alarm handling for more details.

Step4: click Area button, a dialog box will pop-up as Fig 4-24:



Fig 4-24 motion-area

Step5: in the Area interface, user can drag slide bar to set the sensitivity value (1-8), the default value is 4. The higher the value is the higher sensitivity you get. Due to the sensitivity is influenced by color and time (day or night), user can adjust its value according to the practical conditions; click  icon, set the whole area as detection area; click  icon, the set detection area will be cleared; click  icon, user can test whether the sensitivity value and motion area are suitable accordingly (refer to following picture) ; Click  icon, to save the setting; click  icon, exit current interface.

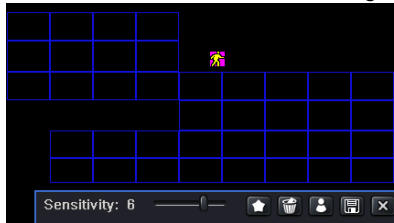

Note: when user drag mouse to set motion detection area, they have to click  icon to clear all set detection

area firstly, and then make the operation.

Step6: user can setup all channels with same parameters, tick off “all”, then to do relevant setup.

Step7: click “default” button to resort default setting; click “apply” button to save the setting; click “exit” button to exit current interface.

② Schedule

Step1: enter into system configuration→alarm configuration→schedule; refer to Fig 4-25:

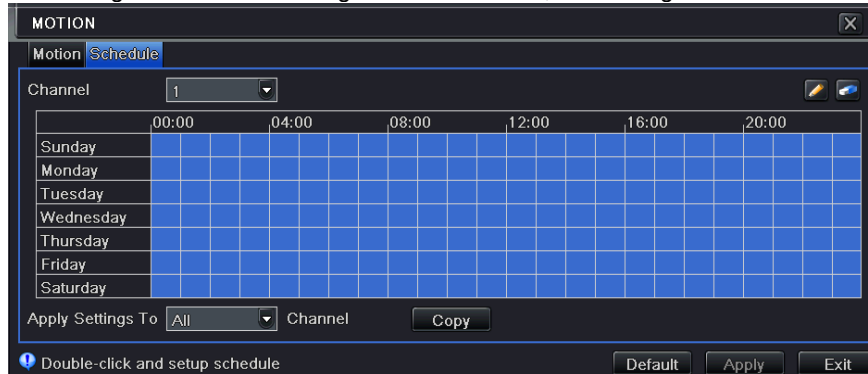

Fig4-25 alarm configuration-schedule

Step2: the setup steps of alarm schedule are familiar with schedule; user can refer to 4.4.1 Schedule for details.

4.5.3 Video loss

Step1: enter into system configuration→alarm configuration→video loss; refer to Fig 4-26:



Fig 4-26 alarm configuration-video loss

Step2: the setup steps of video loss trigger are familiar with alarm handling; user can refer to Chapter 4.5.1 Sensor →alarm handling for more details.

Step3: user can setup all channels with same parameters, tick off “all”, then to do relevant setup.

Step4: click “default” button to resort default setting; click “apply” button to save the setting; click “exit” button to exit current interface.

4.5.4 Other alarm

Step1: enter into system configuration→other alarm; refer to Fig 4-27:



Fig4-27 other alarm

Step 2: **Disk Full**: If the disk is full, the device will auto send an email to users designated mailbox to notify the conflict details.

IP conflict: if there is an IP address conflict within the same network, the device will auto send an email to users designated mailbox to notify the conflict details.

Disconnect: if the disconnect happen, the device will auto send disconnection information to users designated mailbox.

Step3: the setup steps of Buzzer, Email; To Alarm Out is familiar with alarm handling; user can refer to Chapter 4.5.1 Sensor →alarm handling for more details.

Step 4: select a hard disk in the pull down list box, when the disk capacity is lower than that value, there will appear some text information on the lower right of the live image.

Step 5: click “default” button to resort default setting; click “apply” button to save the setting; click “exit” button to exit current interface.

4.5.5 Alarm out

Alarm out includes three sub menus: alarm out, schedule and buzzer

① Alarm out

Step1: enter into system configuration→alarm out; refer to Fig 4-28:

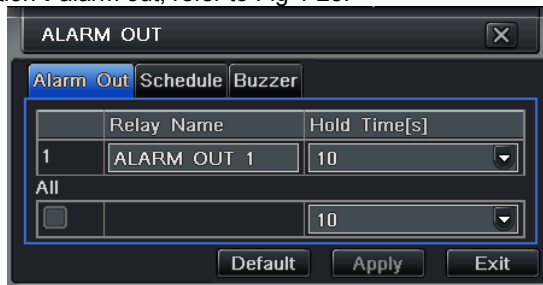

Fig 4-28 system configuration-alarm out

Step2: in this interface, set relay alarm out name, select hold time which means the interval time between the two adjacent alarms.

Step3: user can setup all channels with same parameters, tick off “all”, then to do relevant setup.

Step4: click “default” button to resort default setting; click “apply” button to save the setting; click “exit” button to exit current interface.

② Schedule

Step1: enter into system configuration→schedule;

Step2: the setup steps of alarm out schedule are familiar with schedule; user can refer to 4.4.1 Schedule for details.

Note: the default schedule of motion detection is full-selected, that is, the color of schedule setting interface is blue.

③ Buzzer

Step1: enter into system configuration→buzzer;
Step2: tick off Buzzer, set buzzer alarm hold time

4.6 Network configuration

Network configuration includes two submenus: network and network stream.

4.6.1 Network

Step1: enter into system configuration→network configuration→network; refer to Fig4-29:

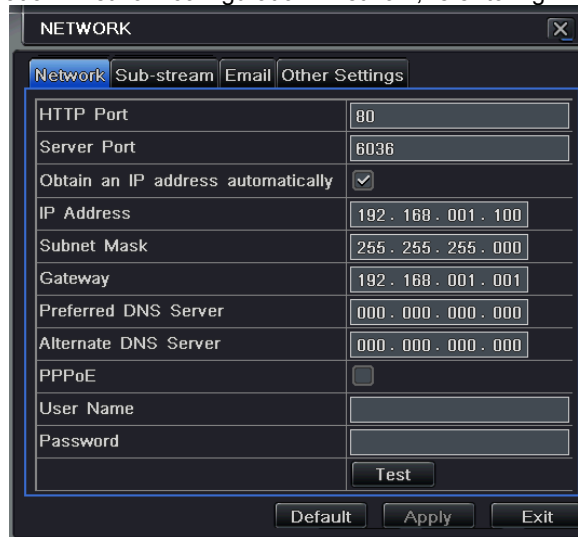

Fig 4-29 network configuration-network

Step2: **HTTP port:** the default value is 80. If the value changed, user needs to add the port number when typing IP address in IE address blank .i.e. set HTTP port to 82, IP address: <http://192.168.0.25>, user needs to input that address: <http://192.168.0.25:82> into IE browser.

Server port: communication port

Step3: Tick off the "Obtain IP address automatically", the device will distribute IP address, subnet mask, gateway IP and DDNS service;

Step4: enable PPPOE, user can directly connect the DVR to internet via ADSL, then input the user name and password; click TEST button to test the effectively of relevant information.

Definitions and descriptions of network configuration:

Parameter	Meaning
HTTP port	The port number of accessing IE browser. The default port is 80
Server port	The port number of data. The default port is 6036
Static IP	
IP address	The IP address of the server
Subnet mask	The subnet mask of the server
Gateway	The gateway of the server
DDNS server	The address of DDNS server
PPPoE	
User name	User name of broad band dial-up
Password	Password of broad band dial-up

4.6.2 Sub stream

Step1: enter into system configuration→network configuration→sub stream; refer to Fig 4-30:

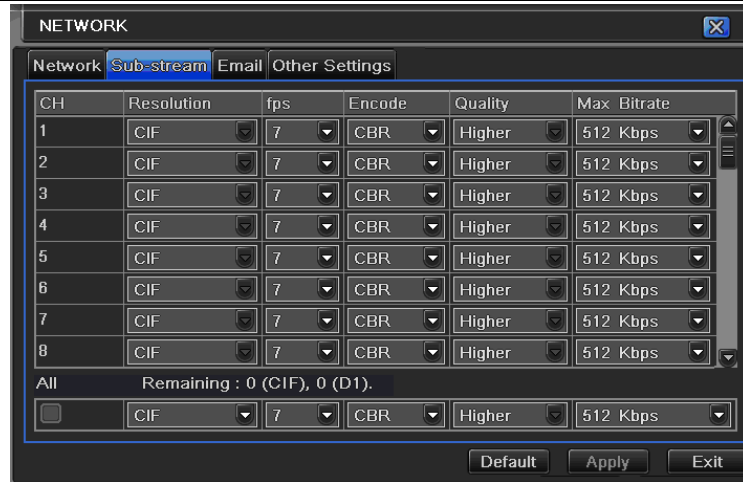

Fig 4-30 network configuration-sub stream

Step2: select fps, resolution, quality, encode and max bit rate

Step3: user can setup all channels with same parameters, tick off “all”, then to do relevant setup.

Step4: click “default” button to resort default setting; click “apply” button to save the setting; click “exit” button to exit current interface.

Note: After selecting Resolution and Fps, the rest fps will be shown.

Definitions and descriptions of Sub stream:

Parameter	Meaning
FPS	Range from: 1-25
Resolution	Support CIF and D1

Quality	The quality of the clients' image. The higher the value is, the clearer the record image. Six options: lowest, lower, low, medium, higher and highest.
Encode	VBR and CBR
Max bit rate	Range from: 64 Kbps、128 Kbps、256 Kbps、512 Kbps、768 Kbps、1Mbps、2 Mbps

4.6.3 Email

Step1: enter into system configuration→network configuration→email; refer to Fig 4-31:

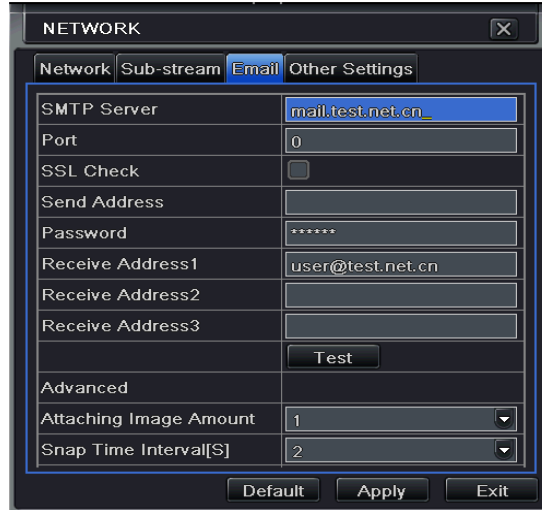

Fig 4-31 network configuration-email

SMTP Server/Port: the name and port number of SMTP server.

Tick off “This server requires a secure connection (SSL)”; user can setup mail servers (such as Gmail) according to actual needs,

Send address/password: sender’s email address/password

Receive address: receiver’s email address. Here user can add at least three mail addresses.

Click TEST button to test the valid of the mailbox.

Attaching image amount: user can attach at most three images at one time.

Snap Time Interval(s): User can select snap time interval.

4.6.4 Other settings

Step1: enable DDNS server: user needs to input user name, password and host domain name of the registered website, click TEST to test the effectivity of relevant information.

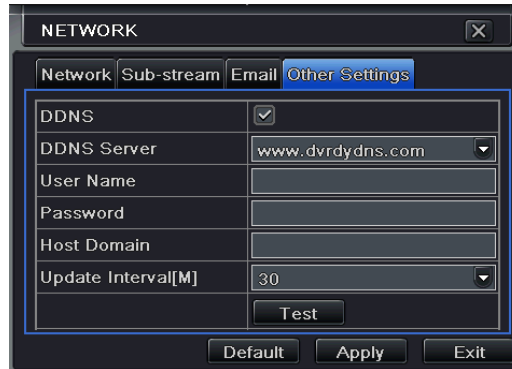

Fig 4-32 network configuration-other settings

STEP2: click “default” button to resort default setting; click “apply” button to save the setting; click “exit” button to exit

current interface.

Note: The domain name server that selected by user is a banding domain name of DVR. User should logon the website which provided by the server supplier to register a user name and password firstly, and then apply a domain name on line for the server. After the successful apply, user can access the server from the IE client by inputting that domain name.

1. Domain name Registration (Take www.dyndns.com for example)

Note: Users can self-define the hostname, username and password.

Input www.dyndns.com in the IE address bar, user can access the domain name registration interface. Click “Sign up Free” and then select the first picture, click “Sign up” to register. For example: Hostname is “abc.dyndns.tv. The picture is shown as follows:

The screenshot shows a registration form with the following fields and options:

- Hostname:** A text input field containing "abc" followed by a dropdown menu showing ". dyndns.tv".
- Wildcard Status:** A label "Disabled" with a link "[Want Wildcard support?]" next to it.
- Service Type:** Three radio button options: "Host with IP address [?]" (selected), "WebHop Redirect [?]", and "Offline Hostname [?]".
- IP Address:** A text input field containing "210.21.229.138". Below it, there is a link "Your current location's IP address is 210.21.229.138" and another link "TTL value is 60 seconds. Edit TTL.".
- Mail Routing:** A checkbox labeled "Yes, let me configure Email routing. [?]" which is currently unchecked.

After user fill in the blank, click “Add to cart”, Dynamic DNS Hosts dialog box will be displayed.

The screenshot shows a dialog box titled "Dynamic DNS Hosts". It contains a list of hosts with the following entry:

- [abc.dyndns.tv](#) -

Then create user account. For example, the username is “bcd”, password is “123456”.

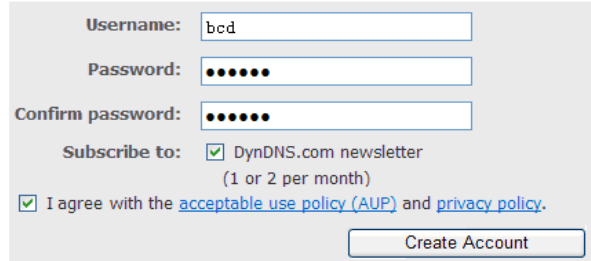

The screenshot shows a user account creation form with the following fields and options:

- Username:** A text input field containing the value "bcd".
- Password:** A password input field with six black dots representing the masked password.
- Confirm password:** A password input field with six black dots representing the masked password.
- Subscribe to:** A checkbox labeled "DynDNS.com newsletter" with the subtext "(1 or 2 per month)". The checkbox is checked.
- Agreement:** A checkbox labeled "I agree with the [acceptable use policy \(AUP\)](#) and [privacy policy](#)." The checkbox is checked.
- Create Account:** A button located at the bottom right of the form.

Click “Create Account” button to create user account.

2. DVR Setting

(1) Domain name

According to the domain name registration of “DDNS”, the domain name for DVR is “www.abc.dyndns.tv”

(2) Username and password

According to the above registration, username is “bcd”.

According to the above registration, password is “123456”

3. Application

Connect DVR to the Network Client.

- ① Enter into Basic configuration, tick off DDNS, select “DynDNS” at the DDNS Sever pull down list box and input user name and password.
- ② Enter into configuration interface of the router, map the server port and IP address. Click Save button to save the setting
- ③ Login IE browser and input registered domain name “www.abc.dyndns.tv”, connect to DVR client.

Note: If the value changed, user needs to add the port number when typing IP address in IE address blank .i.e. set

HTTP port to 82, IP address: http://192.168.0.25, user needs to input that address: http://192.168.0.25:82 into IE browser.

Definitions and descriptions of network configuration:

DDNS server	
DDNS server	Website provided by dynamic domain name supplier. The optional: www.dns2p.net , www.meibu.com , www.dyndns.comandwww.no-ip.com
User name	User name for log in the website of domain name supplier
Password	Password for log in the website of domain name supplier
Host domain	The domain name user registered at the supplier's website.
Update interval	The interval time of upgrading DVR IP address

4.7 User management configuration

Step1: enter into system configuration→user management configuration; refer to Fig 4-33:



Fig 4-33 user management configuration

Step2: click Add button, a dialog box will pop-up as Fig 4-34:

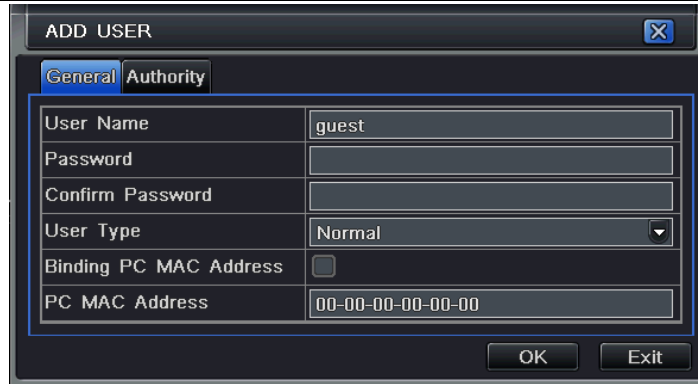

Fig 4-34 add-general

① General: Input user name, password; select user type: normal and advance, input the MAC address of the PC; click OK button, this user will be added into the user list box; click Exit button to exit the current interface.

Note: when the default value of binding PC MAC address is 0, the user is not bind with the specify computer; the, the user can log in DVR on the binding computer after set the specific binding MAC address.

② Authority:

Step1: enter into Add user→authority; refer to Fig 4-35:

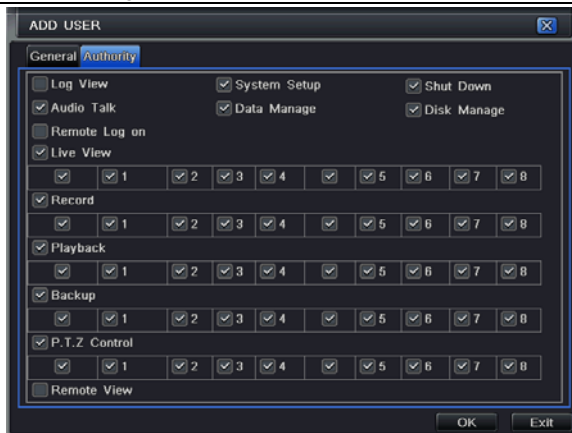

Fig 4-35 add user-authority

Step2: In the authority interface, assign the definite operation right for that user.

Step3: in the user management interface, click Setup button to modify user name, user type and binding PC MAC address.

Step4: select the user that user wants to delete in the user list box, then click Delete button to delete this user.

Step5: click Change password button to modify the password; click Exit button to exit the current interface.

4.8 P.T.Z configuration

P.T.Z configuration includes two submenus: serial port and advance

① Serial port

Step1: enter into system configuration→P.T.Z configuration→serial port; refer to Fig 4-36:

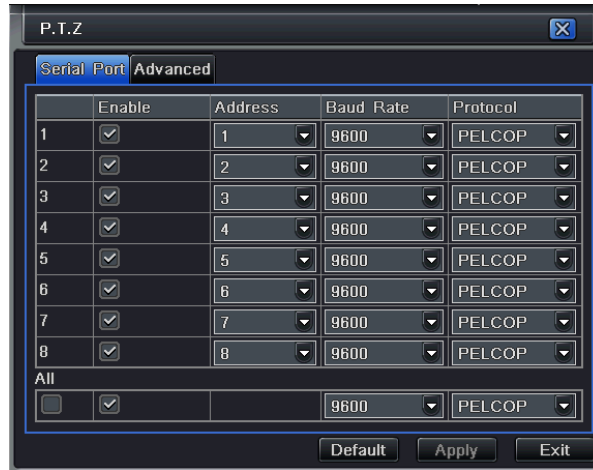

Fig 4-36 P.T.Z configuration-serial port

Step2: tick off Enable, setup the value of address, baud rate and protocol according to the settings of the speed dome.

Step3: user can setup all channels with same parameters, tick off “all”, then to do relevant setup.

Step4: click “default” button to resort default setting; click “apply” button to save the setting; click “exit” button to exit current interface.

Definitions and descriptions of network stream:

Parameter	Meaning
Address	The address of the PTZ device
Baud rate	Baud rate of the PTZ device. Range form: 110、300、600、1200、2400、4800、9600、19200、34800、57600、115200、230400、460800、21600.
Protocol	Communication protocol of the PTZ device. Range from: NULL、PELCOP、PELCOD、LILIN、MINKING、NEON、STAR、VIDO、DSCP、VISCA、SAMSUNG、RM110、HY

② Advance
Step1: enter
configuration→ P.T.Z configuration→advance;

into system



Fig 4-37 P.T.Z configuration-advance

Step2: in the Advance interface, click preset “Setting” button, a dialog box will pop-up as Fig 4-38:





Fig 4-38 advance-preset setting

a. in the preset set interface, click Setting button, a dialog will pop-up as Fig 4-39:



Fig 4-39 preset set-setting

b. user can control the dome rotates up, up left, down, right down, left , left down, right and up right and stop rotating; adjust the rotate speed and the value of zoom, focus and iris of the dome;

c. select the serial number of the preset point, set the preset name. Click Save button to save the settings, click  icon to hide the tool bar, right-key can remerge it; click  icon to exit the current interface.

d. in the preset interface, click OK button to save the setting; click Exit button to exit current interface.

Step3: in the Advance interface, click cruise "Setting" button, a dialog box will pop-up as Fig 4-40:

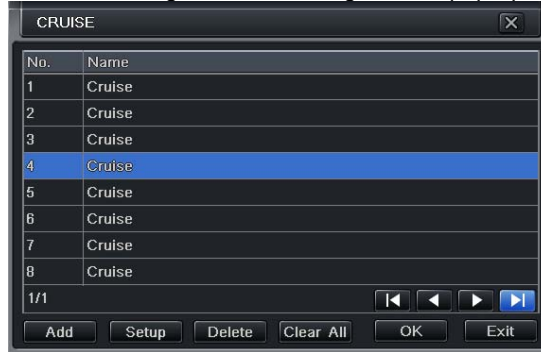

Fig 4-40 cruise set

a. click Add button to add cruise line in the list box (max 8 cruise line can be added); select a cruise line, click Setup button, a dialog box will pop-up as Fig 4-41:

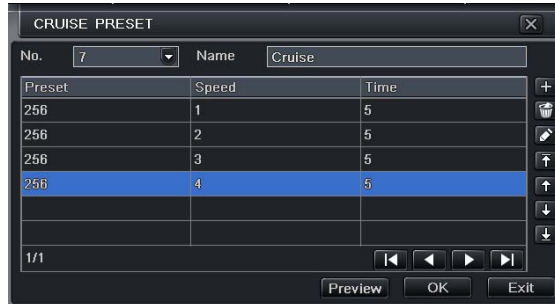









Fig 4-41 cruise set-modify cruise line

- b. click Add icon  to set the speed and time of preset point; select a preset point, click Delete icon  to delete that preset point; click Modify icon  to modify the setting of a preset point. User can click     those icons to adjust the position of preset point. Click Preview button to preview the cruise line, click OK button to save the setting, click Exit button to exit current interface.
- c. select a preset point in the cruise line list box, click Delete button to delete that cruise line; click Clear all button to clear all cruise line from the list box; click OK button to save the setting; click Exit button to exit current interface.
- Step4: in the Advance interface, click track “Set” button, a dialog box will pop-up as Fig 4-42:

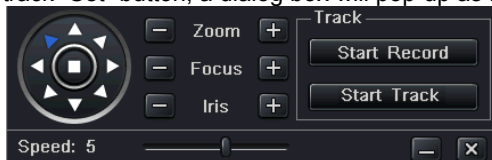



Fig 4-42 track set

- a. user can control the dome rotates up, up left, down, right down, left, left down, right and up right and stop rotating; adjust the rotate speed and the value of zoom, focus and iris of the dome; click Start Record button to record the move track of PTZ, click this button again can stop record; click Start track button to play recorded track, click this button again can stop play.
- b. click  icon to hide the tool bar, right-key can remerge it; click  icon to exit the current interface.
- Step5: in the Advance interface, click “default” button to resort default setting; click “apply” button to save the setting; click “exit” button to exit current interface.

4.9 Advanced

Advanced configuration includes two submenus: reset and import/export.

4.9.1 Reset

Reset all settings the device will reboot.

4.9.2 Import/Export



Fig 4-43 Import/Export

User can export the data files into mobile storage devices as backup function, and then import specified data files from mobile storage device to DVR.

5 Record search & playback and backup

Search configuration includes three submenus: time search, event search and file manager.

5.1 Time search

Step1: enter into Search configuration→time search; refer to Fig 5-1:

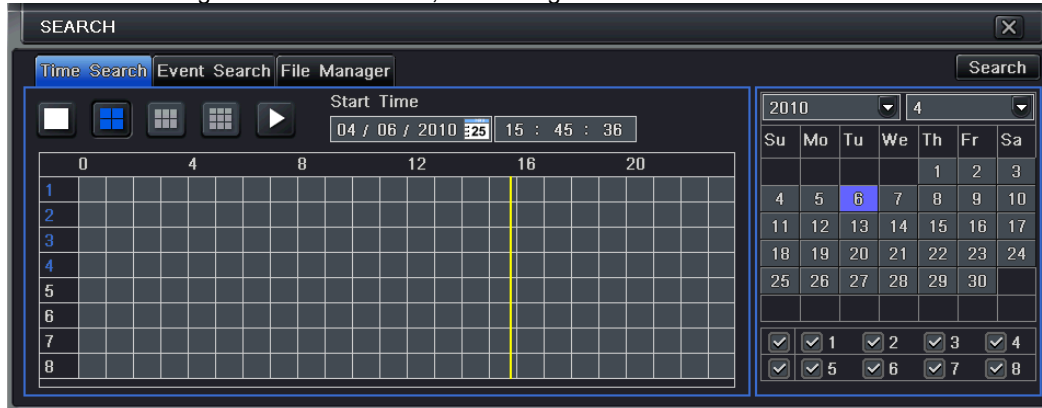

Fig 5-1 Search configuration-time search

Step2: select channel, screen display mode, the highlight date in the calendar means have record data

Step3: select a date, press Search button, click the time grid to set the play start time or input play record time manually. The selected time match the blue grid.

Note: the vertical column means hours, horizontal column means channels.

Step4: click Play  button to playback record; click the relevant buttons on the screen to do operation:

Digital Video Recorder User Manual

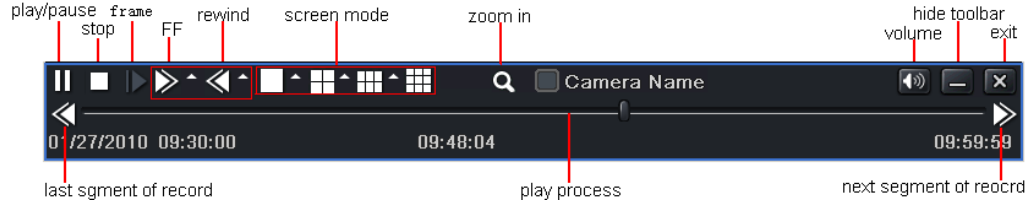

Playback buttons

Note: when the monitor resolution is VGA800*600, the time search interface will appear a hide button, click this button, the whole interface can be expanded.

5.2 Event search

Step1: enter into Search configuration→event search; refer to Fig 5-2:



Fig 5-2 Search configuration-event search

Step2: click Search button, the searched event information will displayed in the event list box, user can select date, channel, tick off Motion, Sensor or All accordingly.

Step3: double check a certain record file to playback.

Note: when the monitor resolution is VGA800*600, the event search interface will appear a hide button, click this button, the whole interface can be expanded.

5.3 File manager

Step1: enter into Search configuration→file manager; refer to Fig 5-3:

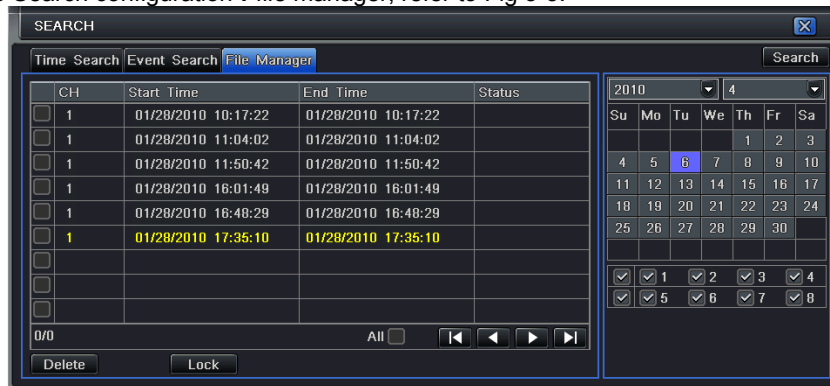

Fig 5-3 Search configuration-file manager

Step2: click Search button, the searched files will be displayed in the file list box, user can select date, channels accordingly.

① Lock: checked a file, click Lock button to lock this file, after that, that file will not be deleted or covered.

- ② Unlock: checked a locked file, click Lock button to unlock this file
- ③ Delete: checked an unlocked file, click Delete button to delete this file.
- Step3: tick off "All" button; user can lock/unlock or delete all files in the file manager column.
- Step4: double click an unlocked item to playback.

Note: when the monitor resolution is VGA800*600, the file manager interface will appear a hide button, click this button, the whole interface can be expanded.

5.4 Backup

This unit supports backup by built-in SATA DVD Writer with USB Flash, through the USB port on the front panel. User also can make backup by IE browser via internet. Refer to 7.3.2 Remote backup.

Step1: enter into backup configuration; refer to Fig 5-4:



Fig 5-4 backup configuration

Step2: set the start & end time, select channels, click Search button, the searched data will be displayed in the data backup

list box

Step3: checked a data file or tick off “All” to select all data files , click Backup button, a dialog box will pop-up as Fig 5-5:



Fig 5-5 backup information

Step4: in the backup information interface, user can check the relevant information of backup files, storage type, save file type, etc. click Start button to starting backup.

Note: when the monitor resolution is VGA800*600, the file manager interface will appear a hide button, click this button, the whole interface can be expanded.

6 Manage DVR

6.1 Check system information

Check system information includes five submenus: system, event, log, network and online user.

6.1.1 System information

In this interface, user can check the hardware version, MCU version, kernel version, device ID, etc. refer to Fig 6-1:

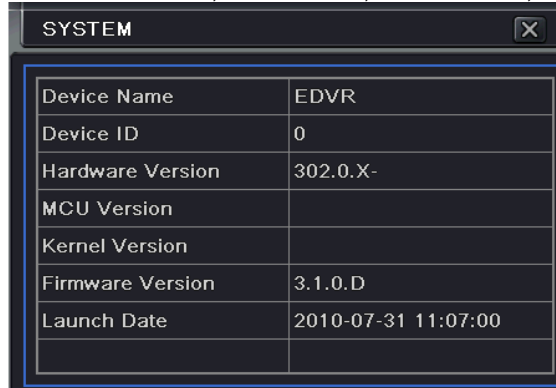

The screenshot shows a window titled 'SYSTEM' with a close button in the top right corner. Inside the window is a table with the following data:

Device Name	EDVR
Device ID	0
Hardware Version	302.0.X-
MCU Version	
Kernel Version	
Firmware Version	3.1.0.D
Launch Date	2010-07-31 11:07:00

Fig 6-1 system information

6.1.2 Event information

In this interface, user can check record events according to set date; refer to Fig 6-2:



Fig 6-2 event information

Note: if there are overlapping files, a "+" character will show behind the channel ID.

6.1.3 Log information

In this interface, user can check relevant log information according to set date; refer to Fig 6-3:

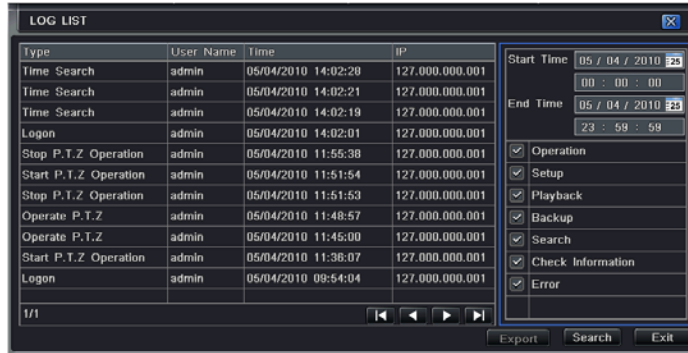
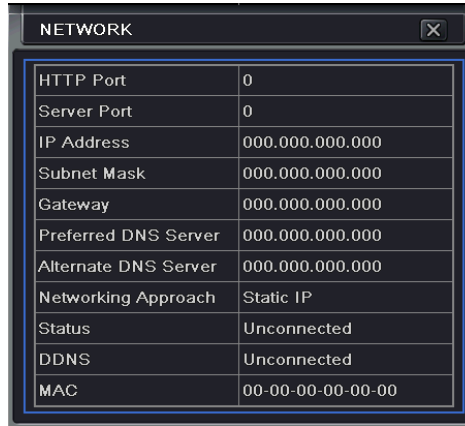

Fig 6-3 log information

User can export the data files into mobile storage devices as backup function.

6.1.4 Network information

In this interface, user can check relevant parameters of network; refer to Fig 6-4:



The screenshot shows a window titled "NETWORK" with a close button (X) in the top right corner. The window contains a table with the following data:

HTTP Port	0
Server Port	0
IP Address	000.000.000.000
Subnet Mask	000.000.000.000
Gateway	000.000.000.000
Preferred DNS Server	000.000.000.000
Alternate DNS Server	000.000.000.000
Networking Approach	Static IP
Status	Unconnected
DDNS	Unconnected
MAC	00-00-00-00-00-00

Fig 6-4 network information

6.1.5 Online information

In this interface, user can check the details of the current connection of online users; refer to Fig 6-5:

Refresh: refresh the current interface.

Disconnect: the administrator authorized to disconnect the client terminal, that PC will not be able to access the device within five minutes.



Fig 6-5 online information

6.1.6 Manual alarm

In this interface, user can check the relevant parameters of manual alarm; refer to Fig 6-6:



Fig 6-6 manual alarm

6.1.7 Disk manager

Step1: enter into disk manager interface; refer to Fig 6-7:



Fig 6-7 disk manager

Note: please format the hard disk before record. If not being formatted, it will show the status of the disk-free space, and total space show OM at the bottom of screen.

Step2: click Refresh button to refresh the disk information of the list box; set the property of the disk then click Apply button to save the setting

Step3: checked a hard disk, click Format button to star format.

Note: all recorded files in the hard disk will be lost after formatted.

6.1.8 Upgrade

At present, it only supports USB update. Get the firmware from your vendor when there is a new firmware version, and make sure it is corresponding with the DVR. User can check the USB information in Disk manager.

6.1.9 Logoff

Click Log off icon, a log off dialogue box will popup, click OK button, the device will log off. If user wants to log in again, click  icon to enter into user name and password to re-login.

7 Remote Surveillance

7.1 Accessing DVR

If making remote view, the DVR must connect with LAN or internet. Then enable network server in the unit. Please refer to 4.6 Network Configuration.

This unit supports IE browser, not any client software installed. In addition, it supports XP and Vista.

7.1.1 On LAN

Step1: Input IP address, Subnet, Gateway. If using DHCP, please enable DHCP in both the DVR and router. Enter Menu—Information—Network, and user can check the network configuration of DVR.

Step2: Enter Video to set network video parameters like resolution, frame rate etc.

Step3: Open IE browser on a computer on the same LAN. Input the IP address of the DVR in IE address blank and enter.

Step4: IE will download ActiveX automatically. Then a window pops up and asks for user name and password.

Step5: Input name and password correctly, and enter. It will show the picture as below.

Digital Video Recorder User Manual

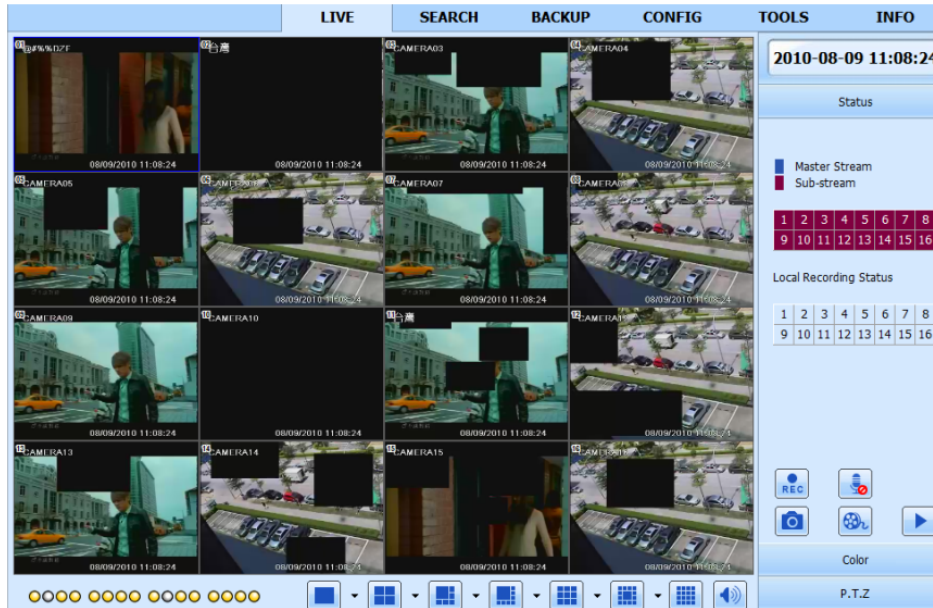



Fig 7-1 View with IE browser

 **Notice:** If HTTP port is not 80, other number instead, need add the port number after IP address. For example, set HTTP port as 82, need input IP address like 192.168.0.25:82.
User name and password here are the same with that used on the DVR. The default is admin and 123456.

7.1.2 On WAN

There are two ways that the DVR is connected to internet.

1. Connect the DVR to internet through a router or virtual server.

Step1: Input IP address, Subnet, Gateway. If using DHCP, please enable DHCP in both the DVR and router.

Step2: Enter Video to set network video parameters like resolution, frame rate etc.

Step3: Forward IP address and port number in Virtual Server setup of the router or virtual server. Close firewall.

 **Notice:** *Forwarding block may be different in different routers and server, please check your router manual.*

If users want to utilize dynamic domain name, need apply for a domain name in a DDNS server supported by the DVR or router. Then add to the DVR or router.

Now this unit only supports www.dns2p.com , www.88IP.net , www.meibu.com , www.dyndns.com, and www.no-ip.com

About the router, please check in the router manual.

Step5: Open IE browser, input IP address, or dynamic domain name and enter. If HTTP port is not 80, add the port number after IP address or domain name.

Step6: IE will download ActiveX automatically. Then a window pops up and asks for user name and password.

Step7: Input name and password correctly, and enter to view.

 **Notice:** *If you cannot download and install ActiveX, please refer to Appendix A FAQ Q7.*

2. Connect the DVR to internet directly.

Step1: Input IP address, Subnet, Gateway gotten from your ISP. If using ADSL, please input user name and password, and click OK. The DVR will connect the server and show "connection succeeds".

Step2: The following steps are the same as STEP4-7 of the connection way above.

7.2 The remote live preview interface as below:

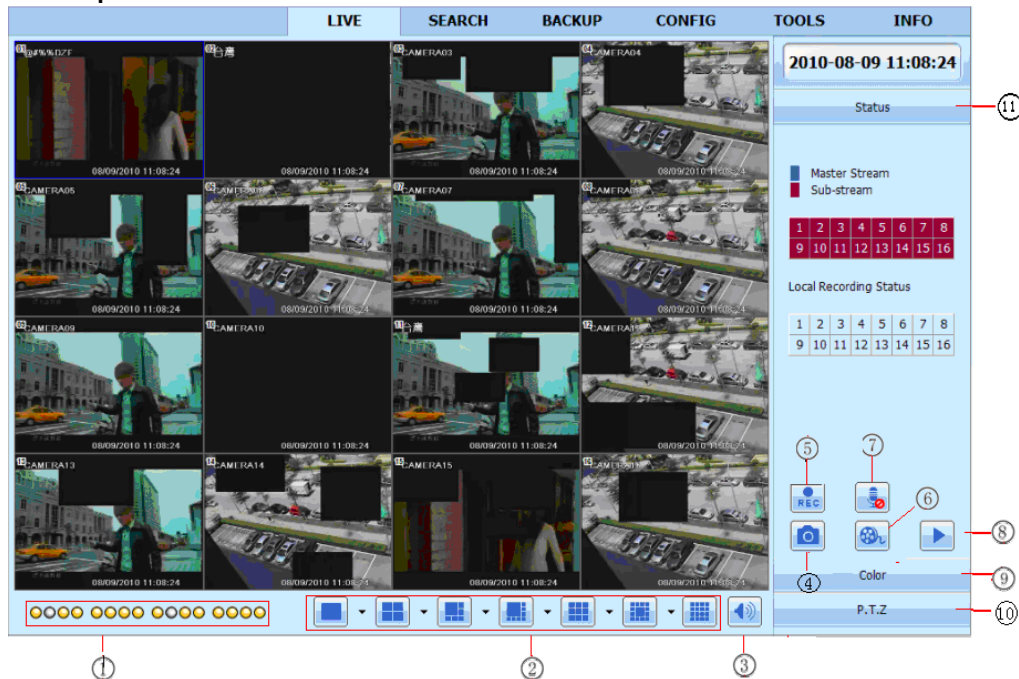

Fig 7-2 Remote live preview interface

Symbol and function Definitions:

①	Channel	②	Screen display mode	③	Volume
---	---------	---	---------------------	---	--------

	indicator				
④	Snapping picture	⑤	Start manual record	⑥	Start IE record
⑦	Bidirectional talk	⑧	Playback	⑨	Color
⑩	PTZ control	⑪	Master/sub stream status		



Note: click **REC** button to record manual and the record file will be saved in user's PC.

Screen display mode:

Click the  icon beside the screen display mode, channel select dialog will appear as below:



Fig 7-3 Channel select dialog

Take 8-channel DVR for example: user can tick off channels form 1-ch to 16-ch at random to display the live pictures, 8 channels can be selected at most. Then click OK button to confirm the setting.

Snap pictures







Click “Snap” icon, the system will automatically capture pictures and save those pictures in the computer.

User should set up the save path for those picture in the Remote Preview interface→Configuration→Local configuration.

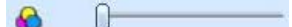
Color adjustment:

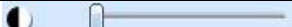

Drag the slide bar to adjust Brightness, Contrast, Hue, and Saturation. Click Default to reset them to original value.













Buttons	Description
	Drag the scroll bar to adjust the brightness of channel
	Drag the scroll bar to adjust the contrast of channel
	Drag the scroll bar to adjust the saturation of channel
	Drag the scroll bar to adjust the hue of channel
	Click this button to recover the default value of brightness, contrast, saturation and hue.
	Save the adjustment

PTZ control

Please connect speed dome to the device via RS485 firstly, make sure the protocol of the speed dome is supported by the device and set the relative parameters manually. User can control the dome up, down, right, left or stop rotating on Control Center, adjust rotation speed, Iris and zoom, focus on the dome, and set the presets, etc.

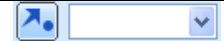
Buttons definition:

Buttons	Description
	▲ means the dome rotate up. ▼ means the dome rotate up left. ▼ means the dome rotate up right ▽ means the dome rotate down. ▲ means the dome rotate left down. ▲ means the dome rotate right down. ◀ means the dome rotate left. ▶ means the dome rotate right. ■ means the dome stop rotating.
	Drag the scroll bar to adjust rotating speed of the dome.

	'Iris' button. Click  button near 'Iris' button to increase light of the dome. Click  button near 'Iris' button to decrease light of the dome.
	'Zoom' button. Click  button near 'Zoom' button to zoom in the locale picture of this camera. Click  button near 'Zoom' button to zoom out the locale picture of this camera.
	'Focus' button. Click  button near 'Focus' button to have long focus. Click  button near 'Focus' button to have short focus.
	Go to the Preset
	Select and do auto cruise
	Track
	Auto scan

Click the right mouse on the live interface, a pull-down menu will appear as below

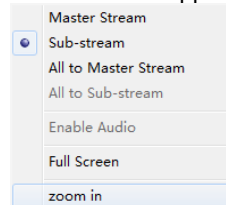

Fig 7-4 right key sub menu

Stream: this DVR supports master stream and sub stream. Master stream has higher frame rate, max 25FPS (PAL) /30 FPS (NTSC) for every channel, but it needs higher network bandwidth simultaneously; second stream has low frame rate,

max 6FPS (PAL) /7FPS (NTSC) for every channel, it requires low network bandwidth. Therefore, users can select the stream according to their bandwidth.

All to master/sub stream: set all channel to master stream or sub stream.

Enable audio: enable or disable audio

Full stream: the live preview picture will display with full screen, the tool bar will be hidden; double click left mouse or click right mouse to return

Zoom in: Single channel large screen electronic amplification

Left click the channel which needs to amplify; Click the right mouse, select Zoom in button and then click the left mouse to amplify the image. Press left mouse to drag the cursor, user can view the image. Double-click the left mouse to exit. Click the right mouse to return to the main interface.

7.3 Remote playback & backup

7.3.1 Remote playback

Click  button to enter into record playback interface, refer to Fig 7-5:

Select the record date and channels; double-click the file name in the record file list box, user can play that file and preview the picture.

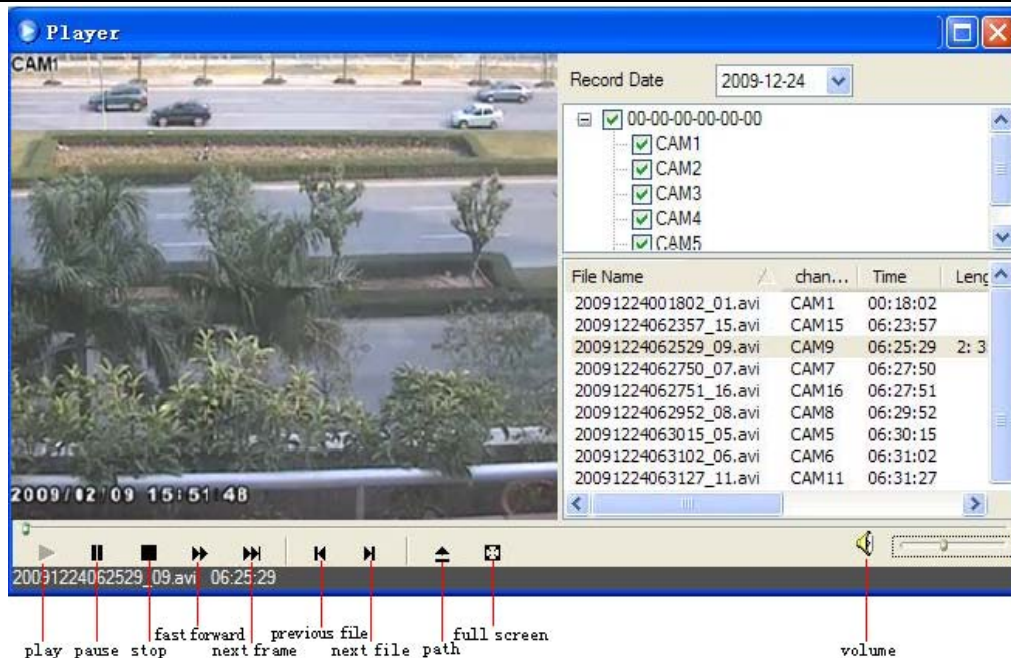

Fig 7-5 Play record file interface

This DVR supports remote time search, event search and file management.

By Time Search:

Step1: Enter into Search→time search; refer to Fig 7-6:

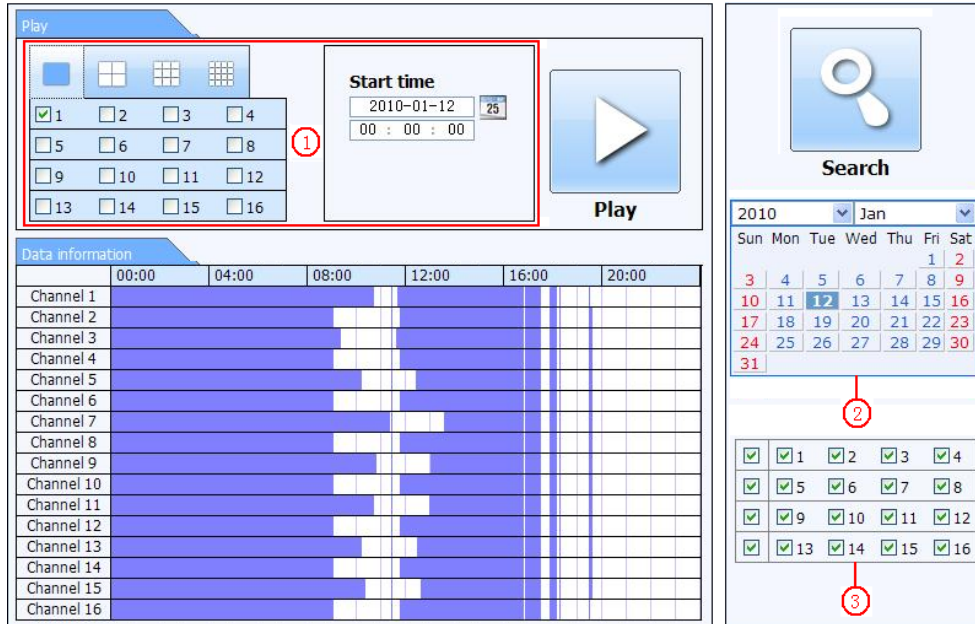

Fig 7-6 time search interface

Step2: click “Search” button. The record data will be displayed in the data information list box; the highlight date in the area ② means have record data, click those data; select the record channels in area③

Step3: User can set the data playing time and display mode in the area① as required

Step4: Select certain item from the data information list box, click “play” button to playback

Step5: Click the relevant buttons in the interface; user can do some operations such as: FF, pause, change channel mode,

research, etc. refer to Fig 7-7:

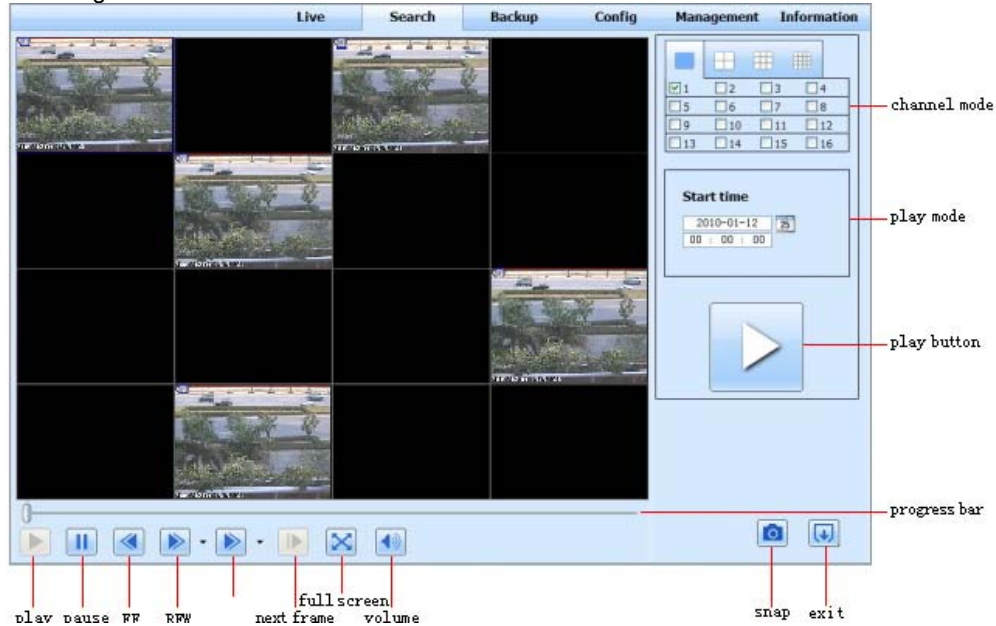

Fig 7-7 Time search playback

By Event Search:

Step1: Enter into Search→event search; refer to Fig 7-8:

The screenshot displays the event search interface. On the left is an 'Event list' table with columns for Channel (CH), Start time, End time, and Type. The table contains 20 rows of event data. On the right is a search panel featuring a magnifying glass icon, a 'Search' label, a calendar for January 2010, and a grid of checkboxes for selecting event types (Motion and Sensor). The calendar shows the 12th of January is selected. Below the calendar is a legend for the checkboxes: a green checkmark for 'Motion' and a green square for 'Sensor'.

CH	Start time	End time	Type
1	2010-01-09 00:01:07	2010-01-09 00:02:16	motion
1	2010-01-09 00:03:28	2010-01-09 01:24:11	manual
1	2010-01-09 00:08:36	2010-01-09 00:09:31	motion
1	2010-01-09 00:10:10	2010-01-09 00:10:58	motion
1	2010-01-09 00:11:30	2010-01-09 00:12:15	motion
1	2010-01-09 00:14:48	2010-01-09 00:15:43	motion
1	2010-01-09 00:15:45	2010-01-09 00:17:09	motion
1	2010-01-09 01:24:11	2010-01-09 02:46:11	manual
1	2010-01-09 02:46:11	2010-01-09 03:19:45	manual
1	2010-01-09 17:39:52	2010-01-09 17:57:12	manual
2	2010-01-09 00:01:07	2010-01-09 00:01:53	motion
2	2010-01-09 00:02:18	2010-01-09 00:03:01	motion
2	2010-01-09 00:03:01	2010-01-09 00:04:12	motion
2	2010-01-09 00:03:32	2010-01-09 00:05:27	manual
2	2010-01-09 00:14:22	2010-01-09 00:15:03	motion
2	2010-01-09 00:21:54	2010-01-09 00:22:35	motion
2	2010-01-09 00:23:51	2010-01-09 00:24:33	motion
2	2010-01-09 00:25:12	2010-01-09 00:25:54	motion
2	2010-01-09 00:26:57	2010-01-09 00:28:43	motion
2	2010-01-09 00:31:48	2010-01-09 00:32:30	motion

1/31

Fig 7-8 event search interface

Step2: click the highlight date and select record channels and then tick off the event type: motion and sensor, click “search” button

Step3: the events will be display in the event list box, double-click certain item to playback

File Management

Step1: Enter into Search→file management; refer to Fig 7-9:

File list

Check	Channel	Start time	End time	Status
<input type="checkbox"/>	1	2010-01-09 00:01:07	2010-01-09 00:02:16	motion
<input type="checkbox"/>	1	2010-01-09 00:03:28	2010-01-09 01:24:11	manual
<input type="checkbox"/>	1	2010-01-09 00:08:36	2010-01-09 00:09:31	motion
<input type="checkbox"/>	1	2010-01-09 00:10:10	2010-01-09 00:10:58	motion
<input type="checkbox"/>	1	2010-01-09 00:11:30	2010-01-09 00:12:15	motion
<input type="checkbox"/>	1	2010-01-09 00:14:48	2010-01-09 00:15:43	motion
<input checked="" type="checkbox"/>	1	2010-01-09 00:15:45	2010-01-09 00:17:09	motion
<input type="checkbox"/>	1	2010-01-09 01:24:11	2010-01-09 02:46:11	manual
<input type="checkbox"/>	1	2010-01-09 02:46:11	2010-01-09 03:19:45	manual
<input type="checkbox"/>	1	2010-01-09 17:39:52	2010-01-09 17:57:12	manual
<input type="checkbox"/>	2	2010-01-09 00:01:07	2010-01-09 00:01:53	motion
<input type="checkbox"/>	2	2010-01-09 00:02:18	2010-01-09 00:03:01	motion
<input type="checkbox"/>	2	2010-01-09 00:03:01	2010-01-09 00:04:12	motion
<input type="checkbox"/>	2	2010-01-09 00:03:32	2010-01-09 00:04:27	manual
<input type="checkbox"/>	2	2010-01-09 00:14:22	2010-01-09 00:15:03	motion
<input type="checkbox"/>	2	2010-01-09 00:21:54	2010-01-09 00:22:35	motion
<input type="checkbox"/>	2	2010-01-09 00:23:51	2010-01-09 00:24:33	motion
<input type="checkbox"/>	2	2010-01-09 00:25:12	2010-01-09 00:25:54	motion
<input type="checkbox"/>	2	2010-01-09 00:26:57	2010-01-09 00:28:43	motion
<input type="checkbox"/>	2	2010-01-09 00:31:48	2010-01-09 00:32:30	motion

0/0



Search

2010 Jan

Sun	Mon	Tue	Wed	Thu	Fri	Sat
					1	2
3	4	5	6	7	8	9
10	11	12	13	14	15	16
17	18	19	20	21	22	23
24	25	26	27	28	29	30
31						

<input checked="" type="checkbox"/>	<input checked="" type="checkbox"/> 1	<input checked="" type="checkbox"/> 2	<input checked="" type="checkbox"/> 3	<input checked="" type="checkbox"/> 4
<input checked="" type="checkbox"/>	<input checked="" type="checkbox"/> 5	<input checked="" type="checkbox"/> 6	<input checked="" type="checkbox"/> 7	<input checked="" type="checkbox"/> 8
<input checked="" type="checkbox"/>	<input checked="" type="checkbox"/> 9	<input checked="" type="checkbox"/> 10	<input checked="" type="checkbox"/> 11	<input checked="" type="checkbox"/> 12
<input checked="" type="checkbox"/>	<input checked="" type="checkbox"/> 13	<input checked="" type="checkbox"/> 14	<input checked="" type="checkbox"/> 15	<input checked="" type="checkbox"/> 16

Fig 7-9 file management interface

Lock: select certain file item in the file list box, click “Lock” button to lock this file that ca not be deleted or overlaid

Unlock: select a locked file, click “unlock” button to unlock this file

Delete: select an unlock file, click “delete” button to delete this file from file list

7.3.2 Remote backup

Click Backup button to enter into backup interface, refers to Fig 7-10:

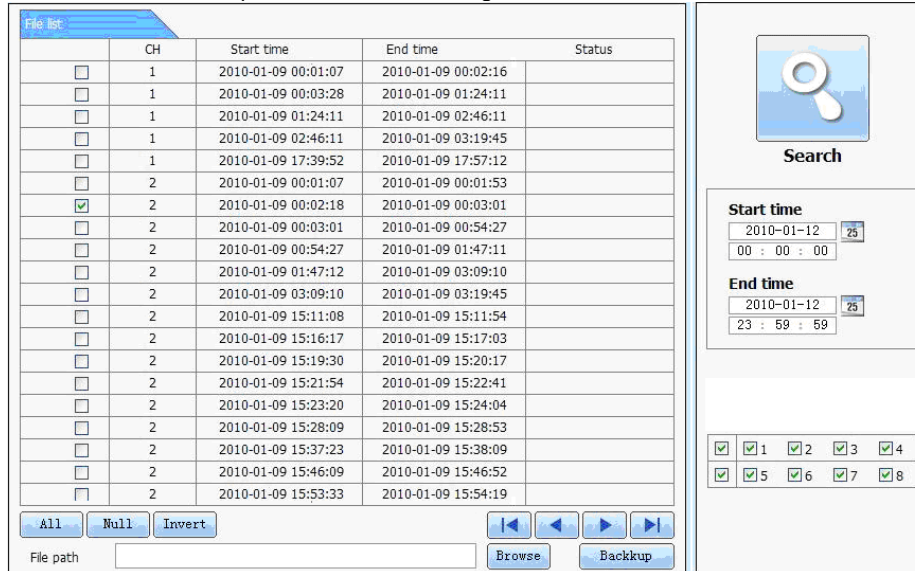

Fig 7-10 remote backup interface

Step1: select channels, set the start and end time, then click “search” button, the file information will be displayed in the file list box

Step2: select backup files, click “browse” button to set the save path, and then click “backup” button to start backup. The backup files will be saved on user’s PC.

7.4 Remote System configuration

User can remote setup the parameters of the device. Functions of remote configurations include: basic configuration, live configuration, record configuration, schedule configuration, alarm configuration, network configuration, PTZ configuration and user configuration. User should firstly select an item in the menu list on the left, and then setup the relative parameters. When one user setup parameters of a certain item, others cannot setup this one. Click Config to enter into the below interface refer to Fig 7-11:

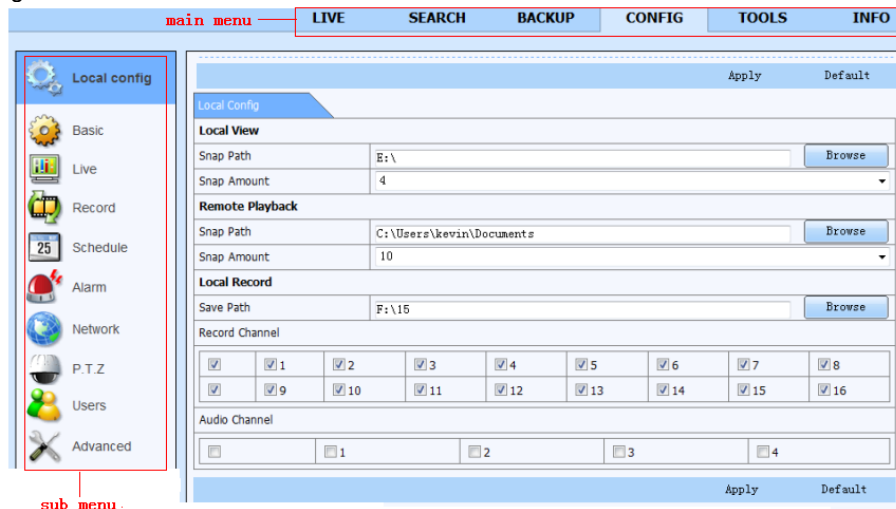

Fig 7-11 remote menu setup

The sub menu lists and the options in every item are similar with those on the DVR. Please refer to Chapter 3 Main Menu Setup Guide for more details.

Click “Apply” button to save above settings; click “default” button will recover the original settings.

7.5 Remote Management

Remote Information Search

The system will automatically record the working condition and operation process during the period of work. User can view information, such as username, IP address and so on. Enter into INFO→Log, user can set the start time to view the log record as follows:

The screenshot displays the 'INFO' section of the DVR interface, specifically the 'Log' search results. The interface has a top navigation bar with 'LIVE', 'SEARCH', 'BACKUP', 'CONFIG', 'TOOLS', and 'INFO'. On the left, a sidebar menu shows 'System', 'Event', 'Log' (selected), 'Network', and 'Online Users'. The main area contains a 'Log List' table with columns for 'Type', 'User Name', 'Time', and 'IP Address'. Below the table are navigation buttons and an 'Export Path' field. On the right, a search configuration panel allows setting 'Start Time' and 'End Time' (both set to 2010-08-09 00:00:00) and a list of search criteria with checkboxes.

Type	User Name	Time	IP Address
Backup Finished	admin	2010-08-09 11:09:42	127.0.0.1
Logon	admin	2010-08-09 11:07:58	172.16.31.232
Logoff	admin	2010-08-09 11:07:53	172.16.31.232
Logon	admin	2010-08-09 11:07:25	172.16.31.232
Logon	admin	2010-08-09 11:07:23	172.16.31.232
Logoff	admin	2010-08-09 11:07:13	172.16.31.201
Logoff	admin	2010-08-09 11:07:13	172.16.31.201
Modify Settings To Handle Vid...	admin	2010-08-09 10:39:48	172.16.31.201
Change Settings To Handle Se...	admin	2010-08-09 10:39:16	172.16.31.201
Change Settings To Handle Se...	admin	2010-08-09 10:39:16	172.16.31.201
Change Settings To Handle Se...	admin	2010-08-09 10:39:16	172.16.31.201
Change Settings To Handle M...	admin	2010-08-09 10:38:51	172.16.31.201
Change Settings To Handle M...	admin	2010-08-09 10:38:51	172.16.31.201
Modify Area For Motion Detect...	admin	2010-08-09 10:38:51	172.16.31.201
Change Settings Of Inbox	admin	2010-08-09 10:37:24	172.16.31.201
Change Settings Of Outbox	admin	2010-08-09 10:37:24	172.16.31.201
Logon	admin	2010-08-09 10:34:26	172.16.31.201
Add User	admin	2010-08-09 10:33:40	172.16.31.201
Add User	admin	2010-08-09 10:33:35	172.16.31.201
Add User	admin	2010-08-09 10:33:29	172.16.31.201

1/5
export Path

Start Time: 2010-08-09 00:00:00
End Time: 2010-08-09 23:59:59

- System Control
- Config
- Playback
- Backup
- Media Search
- View Information
- Error

Fig 7-12 Remote information search

8 Mobile Surveillance

This DVR supports mobile surveillance by Iphone, Gphone or smart phones with Windows mobile and symbian OS. At the same time, it supports 3G network. We tested Dopod D600 (WM5) and Dopod S1 (WM6), which work fine with the DVR. It wants to make mobile surveillance, need first enable network service on the DVR, and refer to Chapter 4.6 Network configuration. The below is the use instructions on mobile client end for two OS.

8.1 By Phones with Windows mobile

Step1: Firstly activate the network access on mobile phone and then run “Internet Explorer”. Input the server’s address and the connection is built up shown as below:

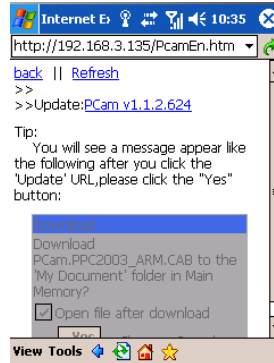

Step2: Click on the software name. A dialog box pops up:

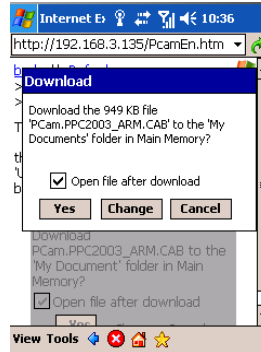

Step3: Click “Yes” to start downloading and installing:

Step4: PCam will be opened automatically after installed

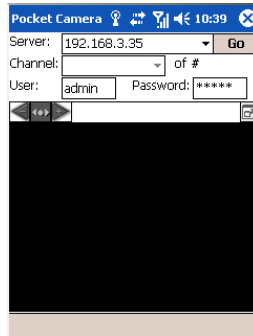

Step5: Input the server's address, ID and password respectively in the columns of "Server", "User" and "Password", and click "Go" to log on the server. It will show the picture if access successfully.

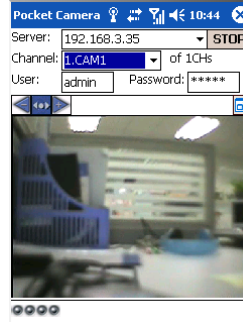

Step6: Camera 1 is the default channel after login. Change the channel in rolling-down menu of "Channel":

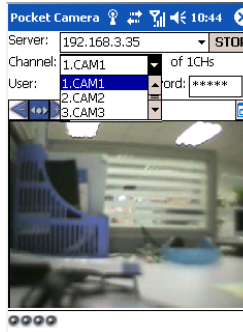

Notice: User name and password here are the same with that used on the DVR. The default is admin and 123456.

8.2 By Phones with Symbian

Please use the smart phones with symbian version supported by this unit.

Step1: Firstly enable the network access on mobile phone. Then run Web browser.

Step2: Input the DVR server's IP address in a new-built bookmark. Click this bookmark to connect to the DVR.



Step3: A welcome window will pop up and requires a package. Click the software name to download

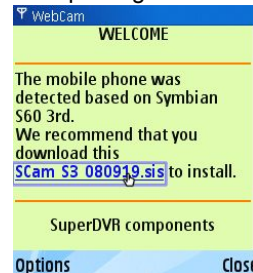

Step4: A security windows will pop up after downloading and ask if install the package. Click YES to install.

Step5: A Scam shortcut icon appears on the system menu after finished.

Step6: Run Scam program. It will enter a function interface.

Live view: to do mobile live view

Image view: to check the pictures snapped in live view

System setting: Login setting and Alarm setting.

Help: function indication and help

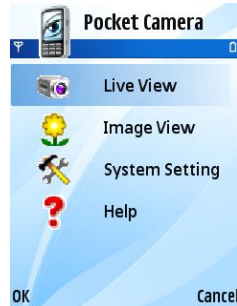

Step7: Click System setting--->Login Setting to enter login interface.



Step8: Input the server's address, ID and password respectively. Then save.

Notice: About Access point, there may be different access points in different countries or from service providers.

Step9: Enter Live View, it will connect the server and display pictures.

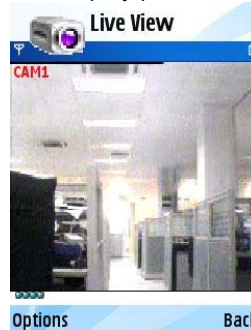

Notice: User name and password here are the same with that used on the DVR. The default is admin and 123456.

Step10: In Live View, users can do snapshot, change channels and control PTZ.



8.3 The operation method for iPhone mobile clients

At present, the software only supports version of iPhone os2.2 and above, if phone firmware lower than this version please upgrade it. Below is the operation method for iPhone mobile clients:

Step1: Enter into App Store function of iPhone

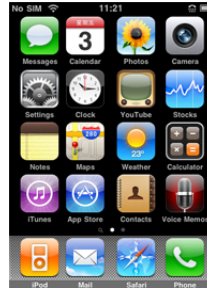

Step 2: Enable “search”  function to search “SuperCam”, the required programs will be displayed on the top of search box

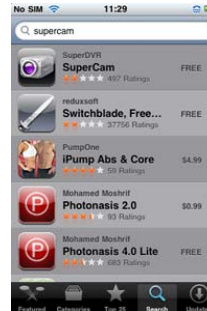

Step 3: Click SuperCam, enter into “introduce” interface and click FREE”, it will change into “INSTALL”



Step 4: Enter into iTunes Store password, click “OK” will display below interface

Note: if it was the first time for user to operate please enter into user ID; if there is no Store account, user need to apply one.



Step 5: Just be patient to download and install. After installed, SuperCam icon will display. Click this icon, a function interface will appear

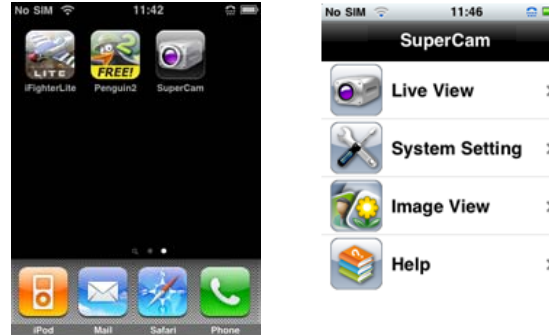

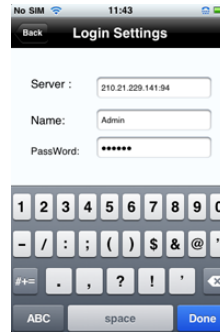

Step 6: Click “System setting”, enter into login interface. Enter into server’s IP address (or domain name), user’s ID and password. Click Back to save.



Step 7: Click Live View, the default Cam1 picture will be displayed. Click  to capture picture.



Step 8: On function interface, click Image View to view the captured picture. Click  or  to switch to next or previous picture. Click  to delete the current picture.



Iphone help





Pic1

Pic2







Pic3

Live View

After successfully installed SuperCam software, Click on System Setting (Pic 1), and then input Server IP address or Domain, User name and password to log in (Pic 2). If connected successfully, it will go to Live View of CH1 as default (Pic 3), please choose other desired channels from channel button underneath. Meanwhile, please note below functions:

1. : Switch channels
2. : Picture snap.
3. : PTZ control (if server camera is PTZ Camera only) (pic4)

PTZ Control buttons:

Item	Buttons	Explanations	Item	Buttons	Explanations
1		pan	2	ZOOM	 Zoom in  Zoom out
3	FOCUS	 Long Focus  Short	4	IRIS	 Lighter  Darker

		Focus			
5		return to live			



Image View



Pic 4

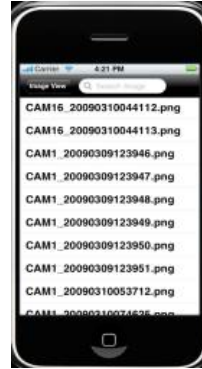

Pic 5

Item	Buttons	Explanations	Item	Buttons	Explanations	Item	Buttons	Explanations
1		Previous picture	2		Next Picture	3		The first Picture
4		The last picture	5		Delete	6		Search Pictures, search page as Pic 5

8.4 The installation & operation methods for Android mobile clients

Software Installation

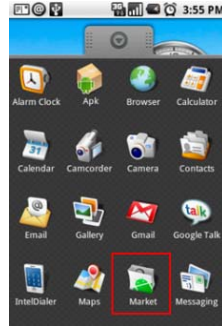

Step 1: run Google Market program

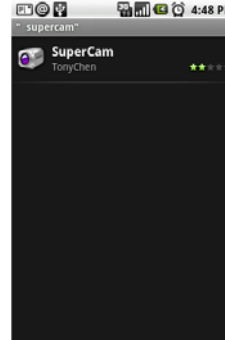

Step 2: search "SuperCam"

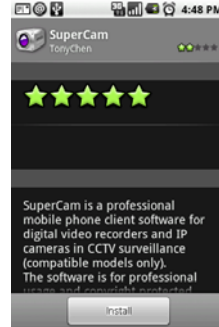

Step 3: press "Install" button

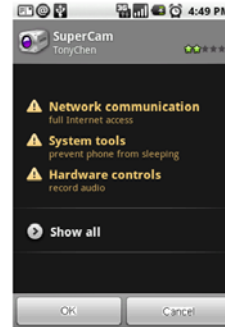

Step 4: click "OK" button

Digital Video Recorder User Manual

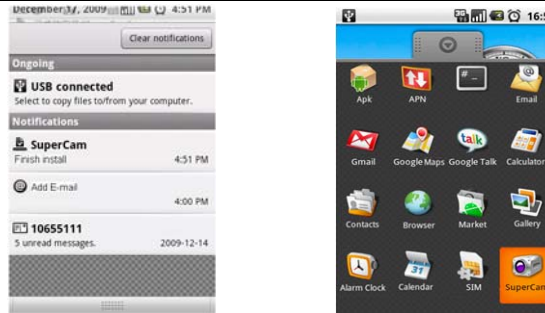

Step 5: user can view the download and install process in notifications; finished download, the software will install automatically.

Login



Enter into server's IP address (or domain name), user's ID and password.

Click "Remember server" to save the setting; click ▼ button can quick input saved server address, user name and password.

Main menu

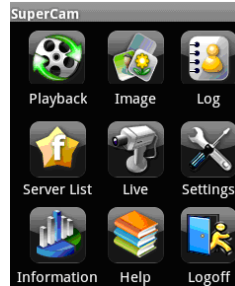

【Playback】	playback record file	【Image】	image view	【Live】	live view
【Log】	log record	【Server List】	device list	【Settings】	software setting
【Information】	device information view	【Help】	software help center	【Logoff】	logoff and return to login interface

Live view



(Fig 1)



(Fig 2)

Mark 1	Current viewing channel	Mark 2	Channel status
---------------	--------------------------------	---------------	-----------------------

Digital Video Recorder User Manual





















	Switch channels		PTZ, click to switch to Fig 2 interface
	Snap		record
	talk		Live audio
	Full screen		Return
	Upward rotates the PTZ		Downward rotates the PTZ
	Leftward rotates the PTZ		Rightward rotates the PTZ
	Stop rotates the PTZ		Zoom In/Focus In/Iris Add
	Zoom Out/Focus Out/Iris Sub	Preset	Select the preset point
Group	Set the cruise line		

Image view



-  Previous
-  Next
-  Zoom in
-  Zoom out
-  Delete
-  Return to main menu

Record playback

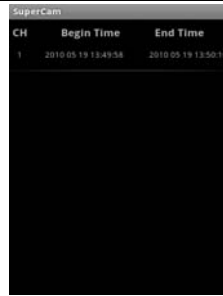

(Fig 3)



(Fig 4)

Click the record file (Fig 3) to playback (Fig 4)

	Play/pause		stop
	Full screen		Return to record file interface (Fig 3)

Server list

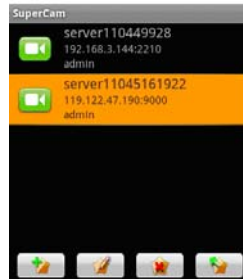

- Add a sever list
- Modify a sever list
- Delete a sever list
- Return to main menu

Config interface

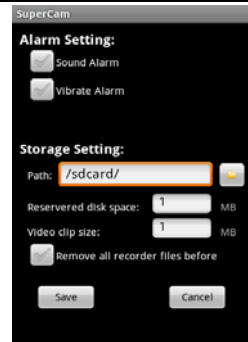

Alarm setting	Tick off Sound Alarm, when Video Loss/Sensor/Motion happen, trigger sound alarm; Tick off Vibrate Alarm, when Video Loss/Sensor/Motion happen, trigger vibrate alarm
Storage setting	User can setup the relevant parameters of mobile video. This function can be valid only insert SD card.
Path	Save path for mobile video files, the default catalog is /SDCard/. Click  button to change path.
Reserved disk space	reserved SDCard disk space, when the disk space is less than setup value, the video will be stopped
Video clip size	Single video size. When the video size is greater than setup value, change another video files
Remove all recorder files before	delete all current video files

Information view



Device ID: the current connection device ID

Software version: The current connection device software version

Build date: the current connection device build date

Software version: The current use of mobile phone software version

Software build date: the current use of mobile phone software version

Appendix A FAQ

Q1. Why the DVR cannot start after connected to the power?

- a. The adapter has been damaged. Please change an adapter
- b. The power of the adapter is not enough. Please remove the HDD to check
- c. Hardware problem

Q2. There is not menu output or only has live image display

- a. Check up whether other devices can display menu or long press ESC key to wait for login dialog box to appear.

Q2. The indicator of the DVR lights, but no output. Why?

- a. The power of the adapter is not enough. Please remove the HDD or change an adapter to try.
- b. The video format of the DVR is different from that of the monitor.
- c. Connection problem. Please check the cable and the ports of monitor and DVR.

Q3. Why are no images displayed on parts or all of the channels of the DVR?

- a. Connection problem. Please check the cable and the ports of camera and DVR.
- b. Camera problem. Please check the cameras.
- c. The video format of the DVR is different from that of the cameras. Please change DVR system format.

Q4. Cannot find HDD

- a. The power of the adapter is not enough. Please change an adapter to try.
- b. Connection problem. Please check the power and data cables.
- c. The HDD is damaged. Change a new one.

Q5. Cannot record

- a. Don't format HDD. Please format it manually first.

- b. Don't enable record function or incorrect setup. Please refer to Chapter 5 Record search & playback and backup.
- c. HDD is full and not enables recycle function. Please refer to 4.3 Record configuration. Chang a new HDD or enable recycle.
- d. The HDD is damaged. Change a new one.

Q6. Cannot use mouse.

- a. wait 1-2 minutes after mouse connected.
- b. Not detected. Plug/unplug several times.
- c. The mouse is incompatible. Please change a mouse.

Q7. Cannot download ActiveX control.

- a. IE browser blocks activeX. Please do setup following below.
- ① Open IE browser. Click Tools-----Internet Options....

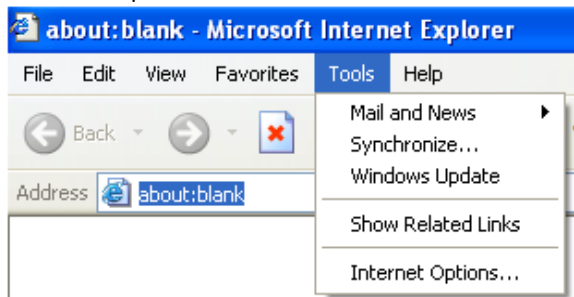

- ② select Security-----Custom Level... .Refer to Fig 7-1
- ③ Enable all the sub options under “ActiveX controls and plug-ins” refer to Fig 7-2

④ Then click ok to finish setup.

b. Other plug-ins or anti-virus block activeX. Please uninstall or close them.

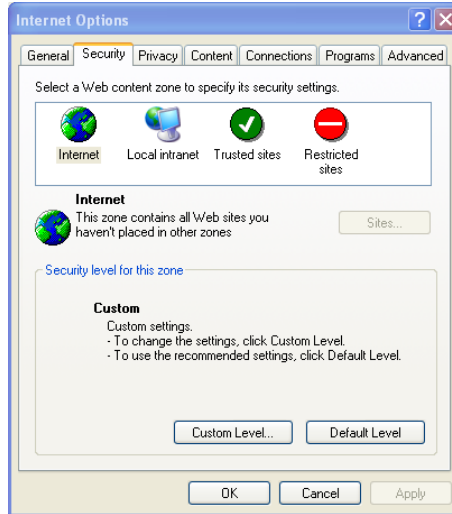

Fig7-1

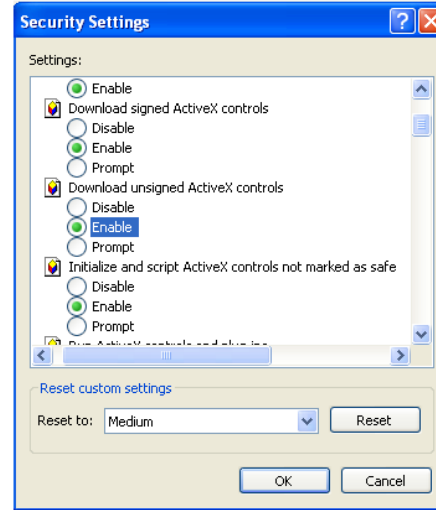

Fig7-2

Q8: How to deal with when DVR starts, it displays “please wait...”all the time

First possible reason: hard-disk cable and data cable are not well connected.

Solution: Please check the connection of hard-disk cable and data cable and make sure they are well connected; If still not working, please unplug them and then try re-plugging again;

Second possible reason: It is forced to stop because hard disk has disabled track which causes the system checking hard

disk cannot skip

Solution: Change another new hard disk or reformat the broken one

Q9: How to input password and digital numbers

The method to input password and digital numbers is to click the box behind *password* or *items* needing to input by numbers, and then the small keyboard will appear. Please select number or letter to input (the initial password is 123456), or you can use the digital keys in the front panel, or the digital keys on the remote controller.

Q10: How to upgrade when added new functions or revised software

After getting the upgraded software from manufacturer, please copy it into U disk, and then select “*upgrade*” in the menu. If upgrading the kernel procedure, please refer to the following method: firstly insert U disk into DVR, and then input “adsws” in the password of system login and the system will upgrade kernel procedure automatically. After finished, please restart DVR to achieve.

Notice: Do not power off in the system upgrading process! Otherwise, it may cause that DVR cannot start.

Q11: Why is the hard disk used in a DVR identified a new hard disk if directly used to another same type DVR? And why must we format it again?

When DVR only uses one hard disk, the hard disk removed from one to another same type DVR can work normally without format. However, when a DVR adds to a new hard disk, it will identify the hard disk as a new one and inquire whether to format no matter whether this hard disk used or not in another same type DVR before. In this condition, it can be used normally after formatted according to the guide; if two or more hard disks used in different DVRs, when used in another DVR with the same type, they will be identified to be two or more new hard disks, and all of them need to format. In general, please do not try using more disks removed from different DVRs into another one in case the data lose.

Q12: What are the minimum configurations of PC for clients connecting?

PC Module	Parameters
CPU	Intel Celeron 2.4G
Motherboard	Intel 845
HDD	80G
RAM	512M
VGA	NVIDIA GeForce MX440/FX5200 ATIRADEON 7500/X300
OS	Windows 2000(SP4 above) /Windows XP(SP2 above) /VISTA
DirectX	9.0

Q13: What are the PC configurations for 16-ch real time product with fully open channel mainstream?

PC Module	Parameters
CPU	Intel Core(TM)2 Duo CPU E4600
Motherboard	G31/P31 chip
HDD	80G
RAM	1GB
VGA	GMA3100/NVIDIA GeForce 8400/ ATI RADEON HD3450
OS	Windows 2000(SP4 above) /Windows XP(SP2 above) VISTA
DirectX	9.0

Q14: How to handle the situation when codec Control is blocked to install in the VISTA or Win7 system?

If user gets this problem, may have two ways to fix it:

- a. Enter Control Panel→User Account and Family Safety → User Account Control(refer to below picture); click Turn User Account on or off. Cancel Use User Account Control (UAC) to help protect your computer.

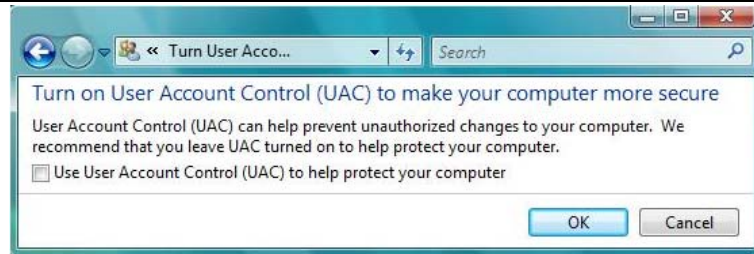

b. Right click IE browser (refer to Fig 14-2), select Run as administrator to run browser.

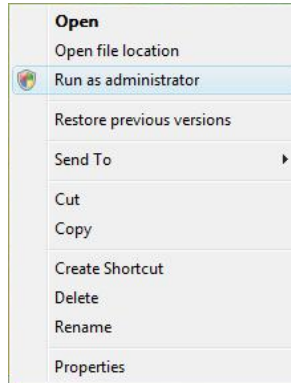

Appendix B Calculate Recording Capacity

Users can calculate the size of hard disk according to the saving time and DVR recording settings. The DVR uses fixed video bit rate. The below are the details at different settings.

Video Format	Resolution	Frame Rate Totally(FPS)	Video Quality	Bit Rate (kbps)	Used Space(MB/h)
PAL	D1	25	Highest	2M	915
			Higher	1.5M	700
			Medium	1M	465
			Lower	768K	297
			Lowest	512K	241
NTSC	D1	30	Highest	2M	910
			Higher	1.5M	712
			Medium	1M	468
			Lower	768K	297
			Lowest	512K	241

The calculation format is:

Total Recording capacity =Used space per hour (MB/h) (coverage rate of hard disk) × recording time (hour) ×channel numbers

For instance, one customer uses PAL cameras, set resolution to D1, video quality to Higher, frame rate to 25 fps for enabling total 4 channels. He wants the unit to record continuously in a month. Below is the calculation:

Total Recoding capacity =700 (mb/h) X 24(hours/day) X30(days) X4(channels)= 2016000(MB)≈2016(GB)

Therefore, customers just install two SATA HDDs with 1000GB, it can almost record for one month.

Appendix C Compatible Devices

1. Compatible USB drive after test.

Brand	Capacity
SSK	512MB, 1G, 2GB
Netac	4GB
Kingston	2GB
Aigo	2GB
Smatter vider	1GB
SanDisk	4GB

Tab C.1 Compatible USB drive

2. Compatible SATA CD/DVD writers after test

Brand	Model
TECLAST	GH22NP20/TL-22XD
BENQ	DW220S-0K4
LITEON	DH—20A6S01C
LITEON	DH-20A4P02C
SAMSUNG	TS-H653B

Tab C.1 Compatible CD/DVD writers

Appendix D 4-CH Specifications

Compression format	Standard H.264 Baseline
Video output	Composite: 1.0V p-p/75Ω BNC×2 , VGAX1
Video input	Composite: 1.0V p-p/75Ω BNC×4
VGA Resolution	1280*1024 /1024*768/ 800*600
Record Resolution	704*576/352*288 (PAL), 704*480/352*240 (NTSC)
Display Frame Rate	100FPS (PAL), 120FPS (NTSC)
Record Frame Rate	100FPS (PAL), 120FPS (NTSC)
Audio input	RCA X4
Audio output	RCA X1
Alarm input	NO or NC 4CH
Alarm output:	4CH
Record Mode	Manual / Sensor /Timer / Motion detection
Simplex/Duplex/Triplex	Pentaplex
Network Interface	RJ45 (LAN, INTERNET)
PTZ control	YES
Communication interface	RS485, USB2.0 x 2(one for backup, another for USB mouse)
Disk info	SATA x 4+DVD-RW x 1 or SATA x 3
Remote controller	YES
Power supply	110V-220V
Temperature	0℃-50℃
Humidity	10%-90%
Average Operating Power (Excluding HDD)	≤30W

Appendix E 8-CH Specifications

Compression format	Standard H.264 Baseline
Video output	Composite: 1.0V p-p/75Ω BNC×2 , VGAX1
Video input	Composite: 1.0V p-p/75Ω BNC×8
VGA Resolution	1280*1024 /1024*768/ 800*600
Record Resolution	704*576/352*288 (PAL), 704*480/352*240 (NTSC)
Display Frame Rate	200FPS (PAL), 240FPS (NTSC)
Record Frame Rate	200FPS (PAL), 240FPS (NTSC)
Audio input	RCA X8
Audio output	RCA X1
Alarm input	NO or NC 8CH
Alarm output:	4CH
Record Mode	Manual / Sensor /Timer / Motion detection
Simplex/Duplex/Triplex	Pentaplex
Network Interface	RJ45 (LAN, INTERNET)
PTZ control	YES
Communication interface	RS485, USB2.0 x 2(one for backup, another for USB mouse)
Disk info	SATA x 4+DVD-RW x 1 or SATA x 3
Remote controller	YES
Power supply	110V-220V
Temperature	0℃-50℃
Humidity	10%-90%
Average Operating Power (Excluding HDD)	≤30W

Appendix F 16-CH Specifications

Compression format	Standard H.264 Baseline
Video output	Composite: 1.0V p-p/75Ω BNC×2, VGAX1
Video Input	Composite: 1.0V p-p/75Ω BNC×16
VGA Resolution	1280*1024 /1024*768/ 800*600
Record Resolution	704*576/352*288 (PAL), 704*480/352*240 (NTSC)
Display Frame Rate	400FPS (PAL), 480FPS (NTSC)
Record Frame Rate	400FPS (PAL), 480FPS (NTSC)
Audio Input	RCA X16
Audio output	RCA X1
Alarm Input	NO or NC 16CH
Alarm output:	1CH
Record Mode	Manual / Sensor /Timer / Motion detection
Simplex/Duplex/Triplex	Pentaplex
Network Interface	RJ45 (LAN, INTERNET)
PTZ control	YES
Communication interface	RS485, USB2.0 x 2(one for backup, another for USB mouse)
Disk info	SATA x 4+DVD-RW x 1 or SATA x 3
Remote controller	YES
Power Supply	110V-220V
Temperature	0℃-50℃
Humidity	10%-90%
Average Operating Power (Excluding HDD)	≤30W